

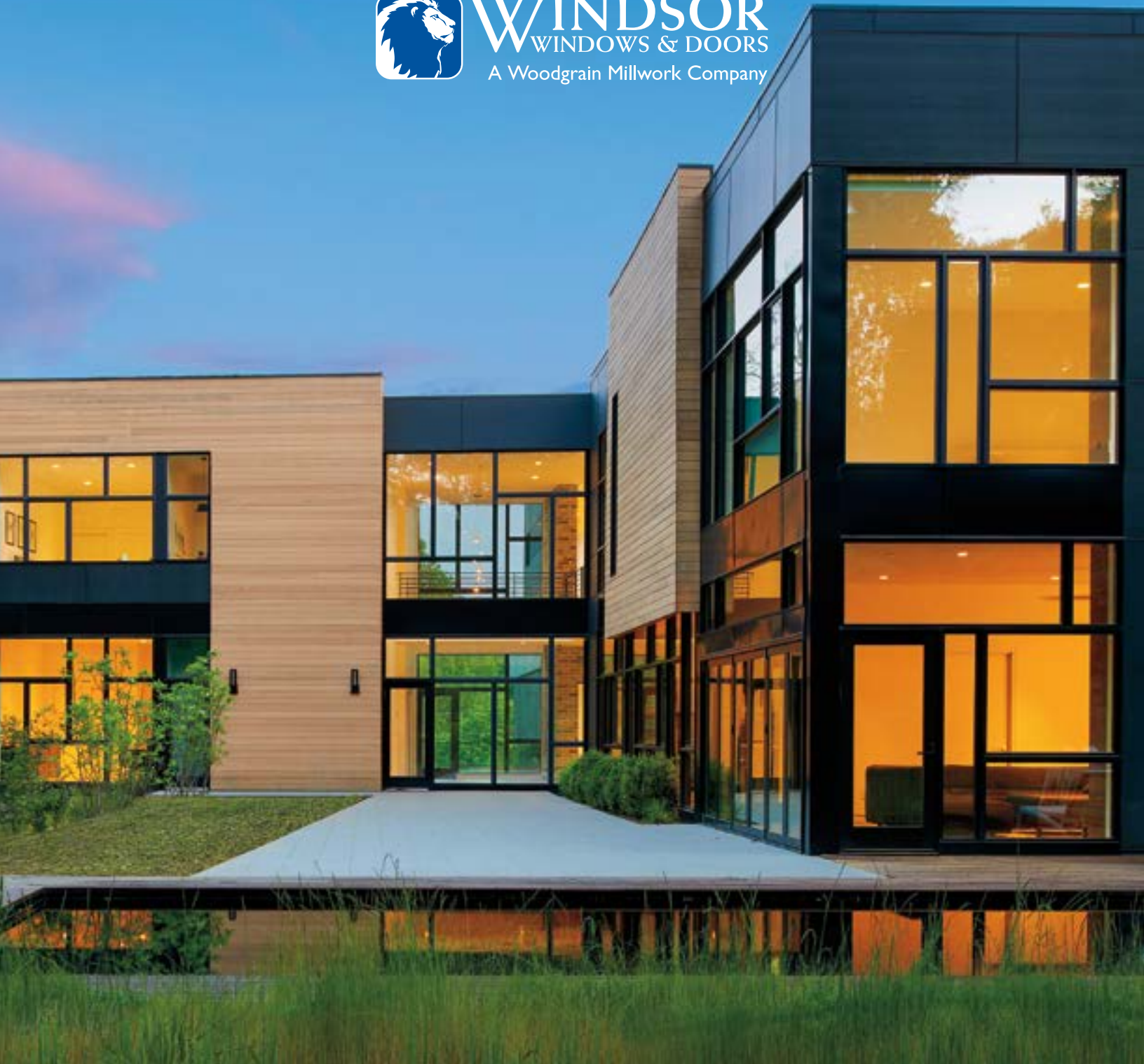

**WINDSOR**  
WINDOWS & DOORS  
A Woodgrain Millwork Company



# PINNACLE

**WOOD CLAD AND PRIMED WINDOWS & DOORS**

[www.windsorwindows.com](http://www.windsorwindows.com)



PINNACLE CASEMENT, AWNING, DIRECT SET AND PICTURE WINDOWS, WITH SWINGING AND SLIDING PATIO DOORS. Cleveland, Ohio.

# Table of Contents

<b>The Wonders of Wood</b> ( <i>Product Details / ENERGY STAR® / Warranty Information</i> ) .....	4-5
<b>Pinnacle Select Casement &amp; Awning</b> .....	6-7
<b>Casement &amp; Awning</b> .....	8
<b>Direct Set &amp; Radius</b> .....	9
<b>Double Hung &amp; Glide-by</b> .....	10
<b>90-degree Corner Window</b> .....	11
<b>Sliding Patio Doors</b> .....	12
<b>Swinging Patio Doors</b> .....	13
<b>Bi-fold Patio Doors</b> .....	14
<b>Multi-slide Patio Doors</b> .....	15
<b>Options &amp; Accessories</b> .....	16-24
<b>Size Specifications &amp; Technical Drawings</b> .....	25-80





# Imagine a Solution for Any Situation

**Windsor Windows & Doors can help bring your vision to life.**

Our windows and doors open up a home to the light, air and beauty of the outside world. But it's the inspired designs and lasting performance of Windsor products that open up a world of possibilities for architects and builders.

Windsor has been developing unique home construction solutions for more than 70 years. We're dedicated to bringing you the highest quality products on the market, all for the best value.

Choose from a wide selection of products for new construction, remodeling or light commercial applications. Windsor's windows and doors allow you to get creative with your next project, without sacrificing quality or stretching your budget.

***Imagine what you can do with Windsor Windows & Doors.***



**LEFT // PINNACLE 3/4 LITE OUT-SWING PATIO DOOR.** Bluffton, South Carolina  
(Courtesy of Coastal Living Magazine/Josh Gibson).

**RIGHT // PINNACLE LOW PROFILE DIRECT SET WINDOWS AND IN-SWING PATIO DOOR.** Winter Park, Florida.

imagine a solution for any situation



# The Wonders of Wood

**Strength and beauty shine through in Windsor's Pinnacle products.** We use only the finest pine, alder and fir so you can create only the finest homes. The many sizes and shapes available allow you to make a statement – from contemporary looks to classic lines.

No matter what design you have in mind, Windsor allows you to achieve it in style. With each Pinnacle product, you get the rugged durability and traditional appeal of real wood.

## See What Sets Pinnacle Apart

**[1] PREMIUM WOOD CONSTRUCTION** Natural wood serves as one of the most energy efficient materials available. Windsor uses only the finest wood interiors of Clear Select Pine, Natural Alder or Douglas Fir.

**[2] CARDINAL® LoE 366 GLASS** Windsor products feature LoE 366 glass with a coating that alters the way glass transmits visible and invisible light. LoE 366 decreases heat loss in the winter and heat gain in the summer. Reduced ultraviolet light penetration also helps prevent your furniture, drapes and carpet from fading.

A triple-glazed IG option is available for Pinnacle Select and Pinnacle clad direct set and radius units. Triple IG consists of 1-1/4" OA thickness and two LoE coatings.

The LoE 366 coating on surface #2 and the LoE 180 coating on surface #5 provides superior U-value thermal performance.

**[3] EXTRUDED ALUMINUM** We use only heavy-duty .050 extruded aluminum cladding, versus thin roll form aluminum. It is sturdier and more resistant to exterior damage, including dents and chips. The powder coat used in our paint application is the extremely durable 2604 finish. The 2605 finish is available when your project requires an even stronger defense against the elements. All Pinnacle clad and Select casement and awning products feature a thermally-broken frame for improved efficiency.

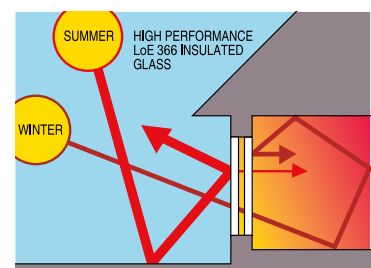





PINNACLE DIRECT SET AND PICTURE WINDOWS WITH AWNINGS.  
Silver Lake, Wisconsin.



**[4] TAPE AND SILICONE GLAZED** We use silicone and tape glazing methods to ensure a water-tight seal and slow the conduction of heat and cold.

**[5] SUPER SPACER® TECHNOLOGY** Super Spacer dual-seal moisture barrier technology provides one of the most thermally efficient spacers in the marketplace, meeting or exceeding ENERGY STAR® guidelines in all zones. All-foam Super Spacer reduces heat and cold conduction, which results in more comfortable living for homeowners and fewer callbacks for builders.

**STATE-OF-THE-ART LISEC® GLASS FABRICATION EQUIPMENT** Our highly-automated glass line requires no manual manipulation – dramatically reducing seal failures caused by human contact with the glass – while our robotic equipment provides an incredible level of accuracy for a fast and efficient material flow.

**ENERGY STAR PARTNER** Windsor Windows & Doors is proud to be an ENERGY STAR partner. Look for the ENERGY STAR logo on our products, which means those models meet EPA guidelines for energy efficiency. Performance data is available on our website at [www.windsorwindows.com](http://www.windsorwindows.com).

**WARRANTY** Our Pinnacle products offer an industry leading Limited 20/10 Warranty. For more specific information, go to [www.windsorwindows.com](http://www.windsorwindows.com).

### Super Spacer®

#### Reverse dual-seal technology

(Airspace is not filled with argon in products with breathing tubes.)

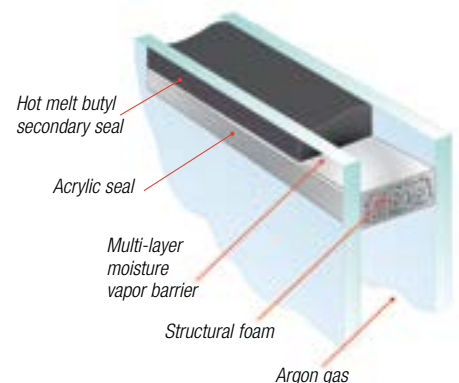



PINNACLE SELECT CASEMENT PICTURE WINDOWS IN PINE WOOD.  
Atlanta, Georgia.





## Pinnacle Select

# Casement & Awning

### Welcome to the peak of perfection in windows.

Pinnacle Select is an elite line of casement and awning windows constructed from enhanced components for unsurpassed performance.



Standard features include 2-5/16" wide stiles and rails for structural stability and architectural appeal, plus a robust 2-3/16" thick sash for dimension and strength. A triple-glazed IG option is available, which features a 2-7/16" thick sash and 1-1/4" OA insulated glass. BetterVue screen material provides improved visibility, airflow and insect resistance. In addition, standard windows include full-width extension jambs and strong DP ratings for structural performance.

Additional options include push-out functionality with stylish hardware, innovative retractable screens and larger frame sizes to accommodate a wider variety of homes. With warranties up to 30 years on Select clad products, homeowners get the ultimate in window performance, stability, style and efficiency.

- [1] Retractable screens have a solid wood pull at the bottom for easy operation. Spring-loaded units pull down from the top and lock into place at the sill.
- [2] Push-out hardware consists of an easy-to-operate lever with cam rollers and keepers, providing a multi-point locking system that is standard. Push-outs are also equipped with adjustable friction hinges and lock rollers.
- [3] Select windows are constructed with 2-5/16" wide stiles and rails that add structural stability and provide a more massive architectural appearance. A robust 2-3/16" thick sash adds dimension and strength and full-width extension jambs are standard on Select units.
- [4] For Select units with 1-1/4" OA triple IG, the sash thickness increases to 2-7/16".

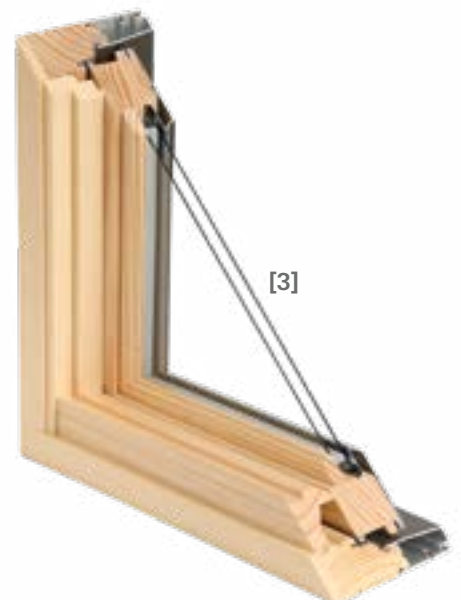



# Casement & Awning

**Simplicity is a thing of beauty.** Casements and awnings provide convenience and energy conservation in one easy-to-use, even easier-to-look-at unit. The Pinnacle casements and awnings offer maximum light, excellent ventilation and simple cleaning. With an endless number of sizes and options, we can make a casement or awning for any room in your home. We use a thick, two-inch sash and our special tape and silicone glazing method to increase insulation and, more importantly, reduce your energy bills. Our sleek, single-lever, multi-point hardware makes for effortless operation and a tight, leakproof fit.

Enjoy an easy-to-operate window available at an incredible value. Pinnacle casements and awnings can help you achieve the cost savings and energy efficiency you need, with the natural wood beauty you want.

Choose a standard frame with various extension jamb depths for a traditional look or a 3-1/4" frame for narrow wall construction or drywall return applications.

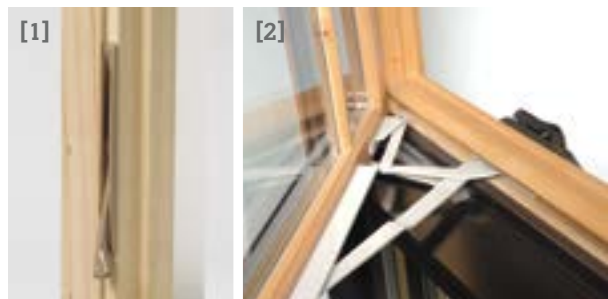

[1] The single-lever lock pulls the sash in at multiple points for a tight seal.

[2] The adjustable hinge system ensures proper alignment after installation and smooth operation for years to come.





# Direct Set & Radius

**Be unique. Be outstanding.** The Pinnacle product line can be customized to suit your home and personality. Enjoy an angle peak at the top of a casement or design a curved shape that's a complete original. Feel free to get creative, because our direct set and radius line of products are all up to the same exacting

measures of energy efficiency and overall quality as our other windows and doors. Custom-shaped windows are a great statement for your home. Plus, with a triple-glazed IG option featuring 1-1/4" OA insulated glass available on Pinnacle clad direct set and radius units, the possibilities are endless.

**NOTE:** Primed direct set and radius units come standard with cellular PVC exterior trim and stops.



PINNACLE RADIUS DIRECT SET WINDOWS AND PINNACLE SELECT CASEMENT WINDOWS. Atlanta, Georgia.



# Double Hung & Glide-by

**We've made your world easier.** Windsor's double hung and glide-by windows are not only an attractive addition to a home, they are extremely easy to maintain. The sash on the double hung easily tilts in and removes for easy cleaning. Our unique locking

shoe balance system also allows you to effortlessly replace or remove individual sashes. Clad units come with heavy-duty .050 extruded aluminum cladding, and primed units feature parts made of revolutionary composite cellular PVC exterior that resists the elements.

Our double hung windows with concealed jambliner feature a full-sized, inverted block and tackle balance, which provides support for a heavier sash. Jamb jacks offer flexibility for adjustment after setting. Installation and alignment is made easier through trim identification lines on the side and head inside stops.

With the concealed jambliner option, you get an enhanced appearance with more wood pieces in the interior jamb covers and head parting stop, offering color-matched aluminum on exterior portions and providing color options for the sill bottom rail weatherstrip to coordinate with cladding colors.

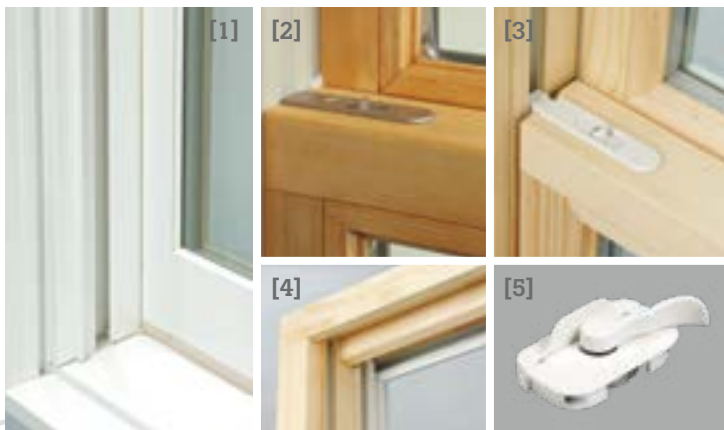

Sash tilts in easily with the help of recessed tilt latches that are color matched to the hardware you choose.

- [1] The sill bottom rail weatherstrip is now available in two colors: bronze and beige. Exterior jamb covers are available in finishes that match the aluminum.
- [2] Double hung without concealed jambliner.
- [3] Double hung with concealed jambliner.
- [4] A trim identification line on the side and head inside stops provides easy alignment during installation. A wood head parting stop replaces a vinyl parting stop.
- [5] Recessed lock and keeper for a sleek appearance.





# 90-degree Corner Window

**Wrap your room in natural light.** Constructed with the same frame as our Pinnacle clad low profile direct set, our 90-degree corner window is designed with clean, straight lines to maximize your view. Corner units are available with a glazed corner post or choose to forgo the post altogether for virtually unobstructed sightlines.\*

Increased visible glass provides a clear view of the outside world, while high-performance thermal ratings maintain a comfortable indoor environment. Whether you want to finish off a sunroom

with architectural interest or create expansive panoramic views in a kitchen, our corner windows offer a stunning option sure to give your project a bold, modern look.



Clear powder coat paint exterior



Pine interior

\*Open units with no corner post will require field glazing by others.

# Sliding Patio Doors

**Smooth, sleek and incredibly charming.** Whether you choose traditional French or contemporary narrow stiles, Pinnacle sliding doors will be the talk of your next outdoor event with their incredible ease and aesthetics. With up to four panels, the doors glide effortlessly on two end adjustable tandem steel ball bearing rollers. Sliding doors have a pultruded fiberglass sill available in a gray or bronze finish. The heavy-duty weatherstripping also ensures your patio doors will be ready for the changing seasons, even when your patio is not.

**NOTE:** Primed sliding patio doors come standard with cellular PVC exterior trim.

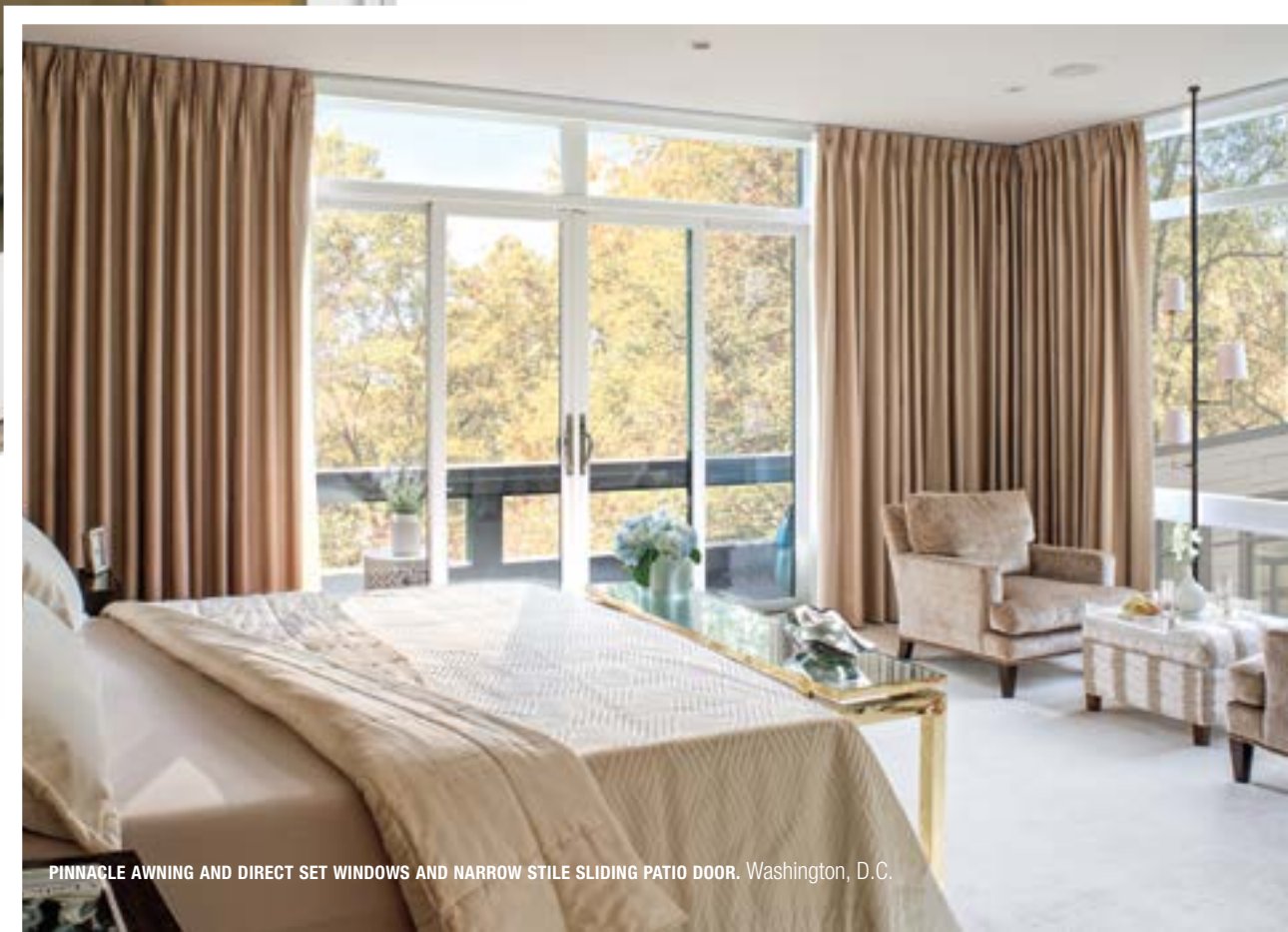





# Swinging Patio Doors

**The highlight of a house.** Your patio is an extension of your home, and your home is an extension of yourself and your style. That's why at Windsor we offer you several options for our Pinnacle swinging patio doors. Choose from in-swing or out-swing models. Add architectural interest to any project by choosing a curved seg-top patio door. Select one panel to operate or two panels. Include up to four panels in one frame. For safety, we can install multi-point locking hardware – for style, we can accent your doors with a customized transom, radius or sidelites. A complement to any home's décor, Windsor's beautifully crafted 1/2 and 3/4 lite panel doors are available in the finest wood interior finishes and offer more customizable features with split panel or flat panel options. The design options continue, with over 50 different exterior clad colors and finishes, several hardware styles, multiple hardware finishes and numerous grille options.

**NOTE:** Primed in-swing patio doors come standard with cellular PVC exterior trim.



PINNACLE DIRECT SET WINDOWS AND OUT-SWING NARROW STILE PATIO DOOR. Washington, D.C.

# Bi-fold Patio Doors



**Open up your world.** Quality, high-performance and stunning beauty come together with Pinnacle bi-fold patio doors. We offer this versatile product in many sizes and configurations, which allows for installation in standard construction openings. This innovative concept brings open-air luxury to virtually any custom project.

Our bi-fold patio doors feature a revolutionary hinge system that will provide graceful operation and reliable function for years to come. With options including three premium hardware finishes, 43 clad colors, eight anodized finishes and a wood interior selection of Clear Select Pine, Natural Alder and Douglas Fir, your possibilities are wide open. Imagine how our bi-fold patio doors can enhance your projects. Homeowners love the way these doors bring the beauty of nature into their home. Pinnacle bi-fold doors are offered in five heights: 6'8", 6'10", 8'0", 9'0" and 10'0" and can be assembled with as few as two panels, and up to eight panels wide. Imagine having the capability to span an opening as high as 10' tall and as long as 24' wide!

## Bi-fold Patio Door Terminology

- |                            |                                  |
|----------------------------|----------------------------------|
| [1] Top pivot              | [6] Wall pivot                   |
| [2] Weatherseal            | [7] Hinge                        |
| [3] Intermediate carrier   | [8] Concealed intermediate guide |
| [4] End carrier            | [9] Hinge with handle            |
| [5] Concealed bottom pivot | [10] Concealed end guide         |

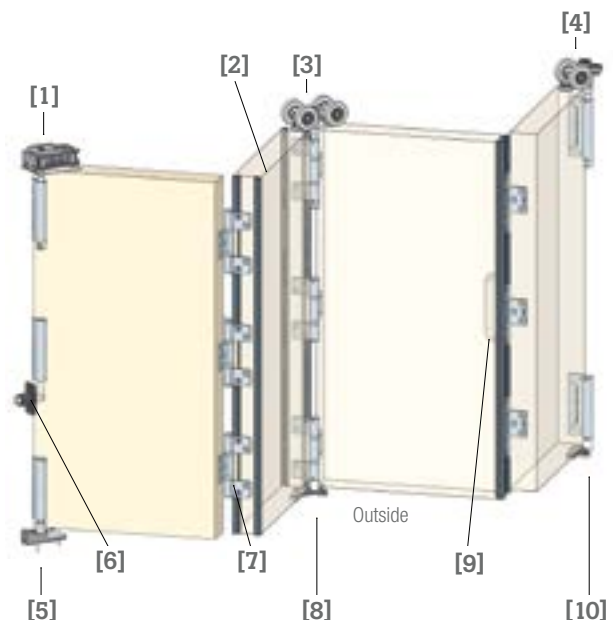





# Multi-slide Patio Doors

**Enhance your views.** Whether your home overlooks a beautiful cityscape or a quiet lake, Pinnacle multi-slide patio doors create an impactful design element. Highlight brilliant outdoor views and give your home a unique architectural look that expands the feel of indoor living space.

Available in stacking or pocket configurations up to 20 feet wide, our clad multi-slide patio doors offer many of the same features as other products in the Pinnacle line. Choose from 22 standard colors, 21 feature colors, one of three wood species, and a variety of glazing options and grille designs. All applications using multi-slide door systems require overhangs equal to or greater than the height of the multi-slide door.



PINNACLE MULTI-SLIDE DOOR WITH THREE NARROW STILE PANELS.  
Eagle, Idaho.

# Custom Creations

**Finishing touches to perfect your vision.** Windsor does more than just create durable, high-performance windows and doors. We pay attention to every detail and offer a wide array of options and finishes to match any décor. Flashy and eye-catching or simple and understated, our hardware, finishes, grille options, cladding colors, glass options and trim options complete the perfect window and door package.

See the difference paint can make. Windsor's in-house powder paint application can help you make a statement with your windows and doors. Choose from over 40 shades in our standard and feature color palettes, or make it truly unique with custom color matching. All paints are protected with the highly durable 2604 finish, or you can upgrade to 2605 for even stronger defense against the elements.<sup>1</sup>

## Standard Clad Colors



## Feature Clad Colors

Custom color matching is also available.



<sup>1</sup>2604 finish backed by a 20-year\* warranty; 2605 finish backed by a 30-year\* warranty; applications within one mile of the coast carry a 10-year warranty. For specific warranty details, please refer to the complete warranty document posted on our website, [www.windsorwindows.com](http://www.windsorwindows.com).



## Anodized Finishes



Clear

Champagne

Light Bronze

Medium Bronze

Dark Bronze

Extra Dark Bronze

Black

Copper

## Interior Wood Species



Clear Select Pine

Douglas Fir

Natural Alder

## Interior Finishes



Primed

Painted White

Painted Black

## Radius Interior Trim

Custom-fitted wood trim for radius-shaped windows and radius-top doors is available in five moulding styles. All styles are available in Clear Select Pine, Oak, Douglas Fir and Natural Alder.



WM 324 • 2-1/4"  
Shown in Clear Select Pine

WM 346 • 2-1/4"  
Shown in Clear Select Pine

WM 356 • 2-1/4"  
Shown in Oak

WM 366 • 2-1/4"  
Shown in Douglas Fir

WM 444 • 3-1/2"  
Shown in Natural Alder

## Casement/Awning Crank and Finishes



Champagne

White

Bronze

Black



Faux Bronze

Oil Rubbed  
Bronze

Satin Nickel

Bright Brass

## Double Hung Lock and Finishes



Champagne

White

Bronze

Black



Faux Bronze

Oil Rubbed  
Bronze

Satin Nickel

Bright Brass

**NOTE:** Printing limitations prevent exact color/finish representation. See your Windsor distributor for actual samples.

options & accessories

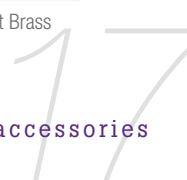



## Exterior Trim

### Cellular PVC Exterior Sill Options (Primed only)



### Cellular PVC Exterior Casing Options (Primed only)



### Clad Exterior Casing Options



**NOTE:** Printing limitations prevent exact color/finish representation. See your Windsor distributor for actual samples.



**Glass** *\*Special order item*

Units with 1-1/4" OA triple IG are only available in LoE 366/180, obscure, satin etch, glue chip, rain and reed glass.

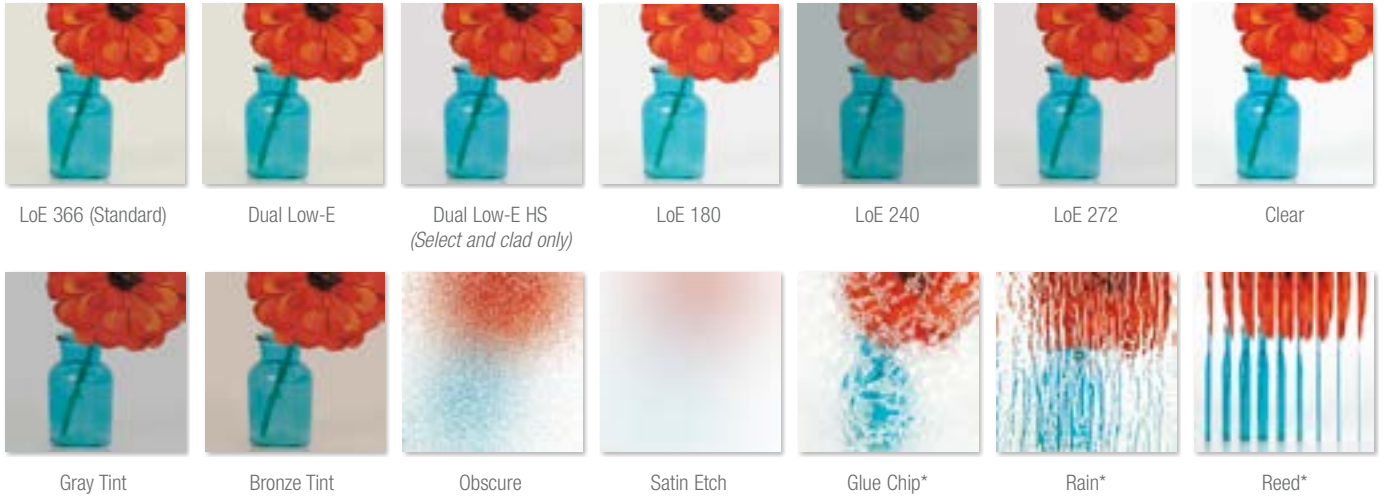

**Direct Set and Radius Options**

**Radius Inner Grille Patterns**

**NOTE:** Before selecting a special grille pattern, confirm alignment with units below.

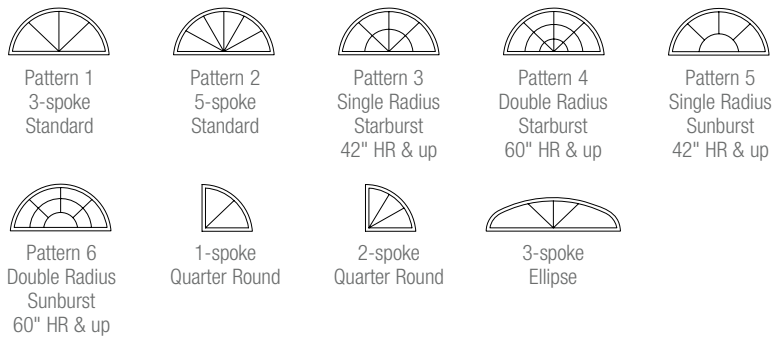

**Radius Special Shapes**



**Direct Set Special Shapes**



**NOTE:** Printing limitations prevent exact color/finish representation. See your Windsor distributor for actual samples.



## Screens

All exterior-applied screens for Pinnacle double hung, glide-by and patio doors come with screen frames matching the clad color of the unit. Interior-applied screens for Pinnacle casement and awning windows have screen frames available in champagne, white, bronze, black, wood-veneered pine, wood-veneered alder or wood-veneered fir.

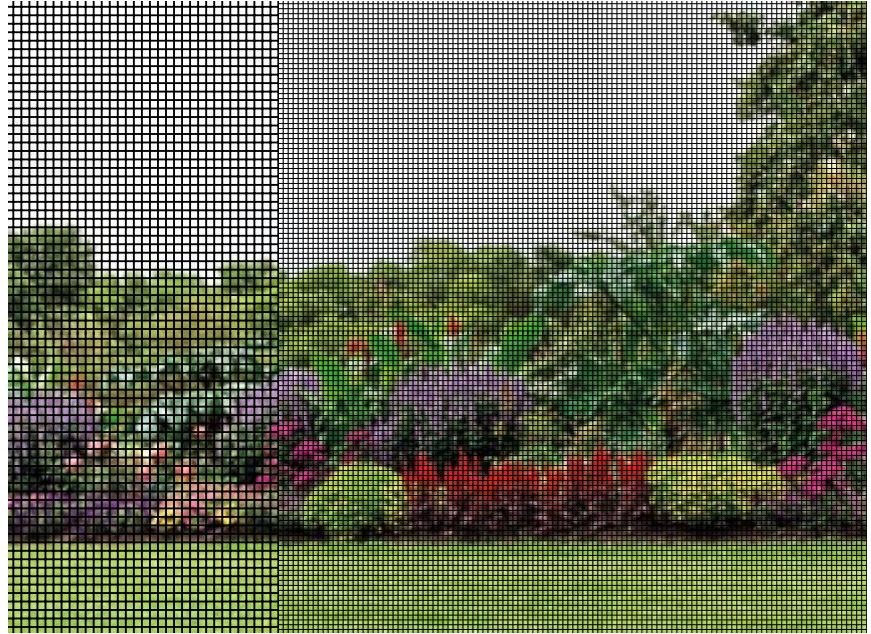

Conventional Screen Mesh

BetterVue® (Standard)

UltraVue®

## Grilles

All of our wood and cellular PVC (CPVC) Windsor Divided Lite bars are hand-fitted to ensure a perfect fit.



7/8" & 1-1/4"  
Perimeter Grille



7/8" & 1-1/4"  
Stick Grille



3/4" & 1"  
Profiled Inner Grille



13/16" Flat Inner Grille  
*(Not available on Select)*



7/8" & 1-1/4"  
Interior Wood  
Windsor Divided Lite



7/8" & 1-1/4"  
Exterior Clad  
Windsor Divided Lite



7/8" & 1-1/4"  
Exterior CPVC  
Windsor Divided Lite  
*(Primed only)*



5/8" & 7/8" Tall Putty  
Windsor Divided Lite



5/8" & 7/8" Short Putty  
Windsor Divided Lite



1/4" Ogee



5/8", 7/8", 1-1/4" & 2"  
Contemporary Windsor  
Divided Lite



5/8", 7/8", 1-1/4" & 2"  
Contemporary Windsor  
Divided Lite



2" Tall Putty  
Simulated Check Rail



2" Exterior Low Profile  
Simulated Check Rail



2" CPVC Simulated  
Check Rail *(Primed only)*



3-3/8"  
Simulated Mid Rail



## Grille Patterns

Some grille patterns are not available in all configurations and products.

### Casement and Awning Grille Patterns

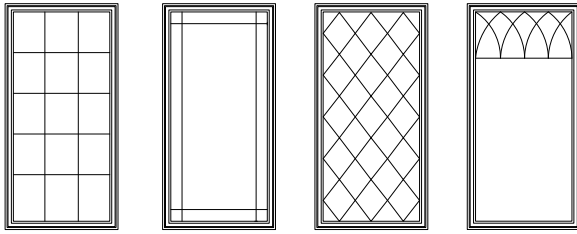

Colonial      Prairie      Diamond      Gothic

### Double Hung Grille Patterns

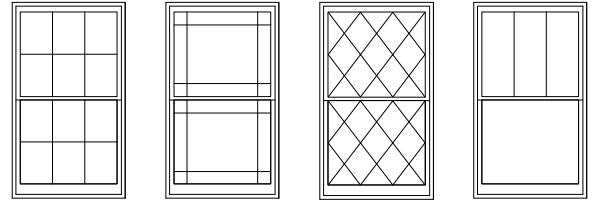

Colonial      Prairie      Diamond      Plaza

### Casement and Awning Grille Patterns

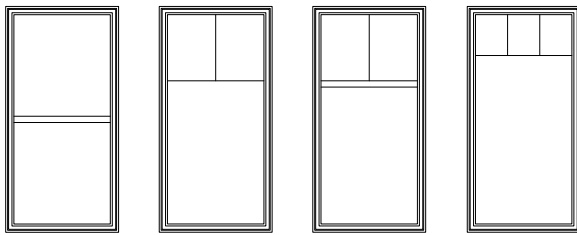

Simulated Check Rail      Custom Plaza      Custom Plaza with 2" Bar      Single Plaza

### Patio Door Grille Patterns

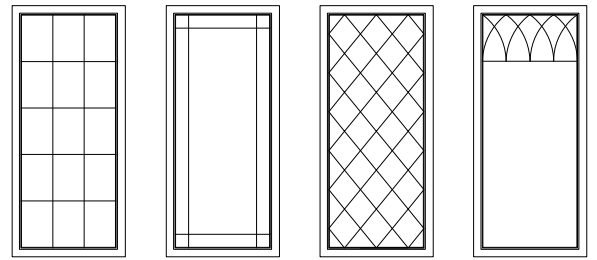

Colonial      Prairie      Diamond      Gothic

### Casement and Awning Grille Patterns

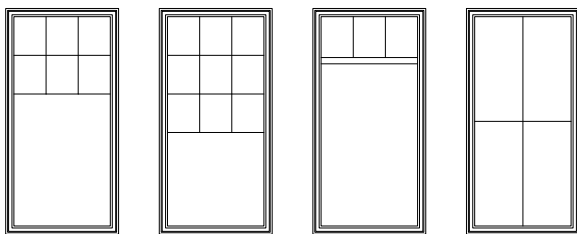

Double Plaza      Triple Plaza      Plaza with 2" Bar      Specified Equal Lite (2x2 shown)

### Patio Door Grille Patterns

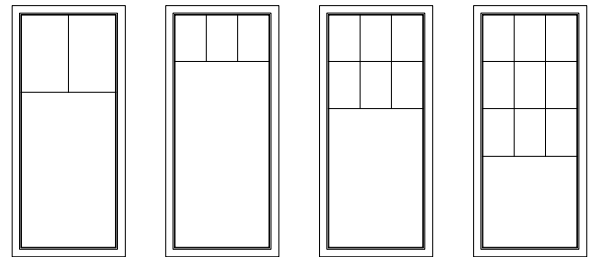

Custom Plaza      Single Plaza      Double Plaza      Triple Plaza

### Casement and Awning Grille Patterns

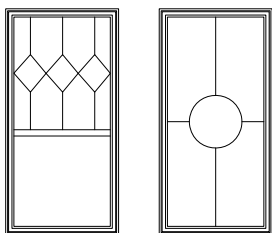

Custom Pattern (Example)      Custom Pattern (Example)

### Patio Door Grille Patterns

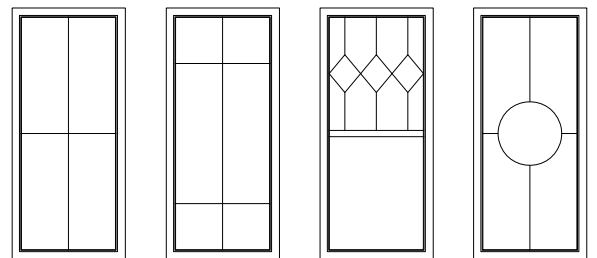

Specified Equal Lite (2x2 shown)      Custom Pattern (Example)      Custom Pattern (Example)      Custom Pattern (Example)

## Grille Profiles

### Interior Grilles – Ogee

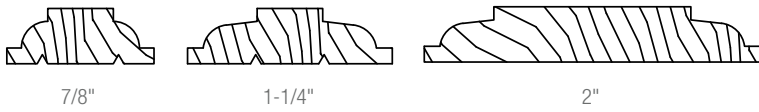

### Interior Grilles – Putty

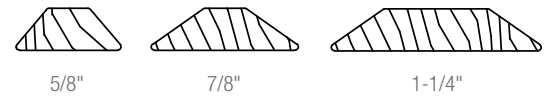

### Interior Grilles – Contemporary

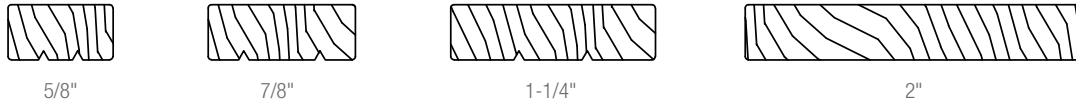

### Exterior Grilles – Ogee



### Exterior Grilles – Putty

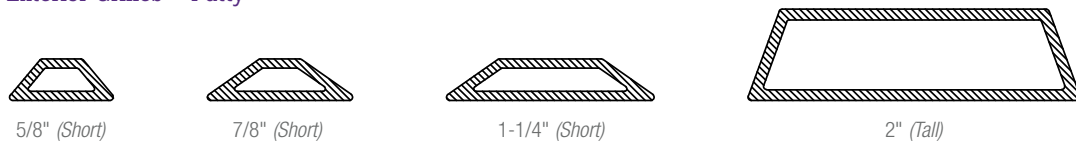

### Exterior Grilles – Contemporary

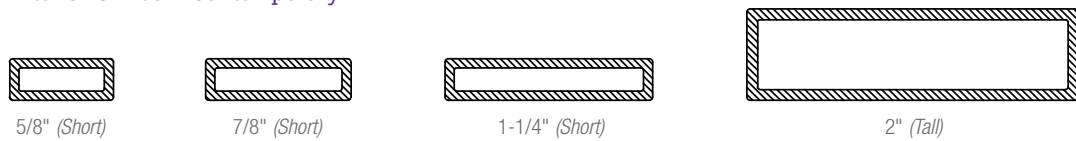

## Grille Sections

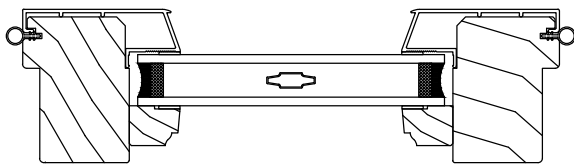

Standard Select IG with Inner Grille

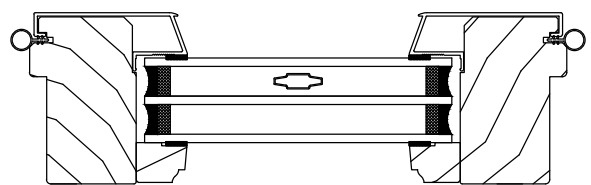

Triple IG with Inner Grille

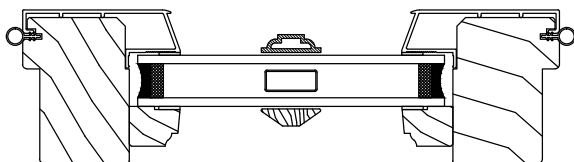

Standard Select IG with WDL  
and Inner Bar

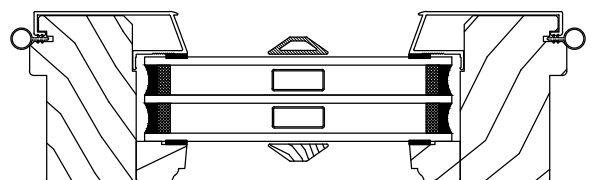

Triple IG with WDL  
and Inner Bar



## Patio Door Handles and Hinges

1/Bi-fold doors are available with a classic or contemporary swinging handle in satin nickel, brass and oil rubbed bronze; 2/Euro swinging handle is only available in satin nickel and black; 3/Flush mount handle is only available in satin nickel, faux bronze, oil rubbed bronze and black.



## Patio Door Handle and Hinge Finishes

All six finishes marked with asterisks feature a clear coating that protects the finish against tarnish and peeling. The finishes marked with a single asterisk (\*) are available in swinging door hardware only. The finishes marked with a double asterisk (\*\*) are available in sliding patio door hardware only. Those marked with a triple asterisk (\*\*\*) are offered in both swinging and sliding door hardware. It extends the rich, bright life of the finish and dramatically delays the aging process.

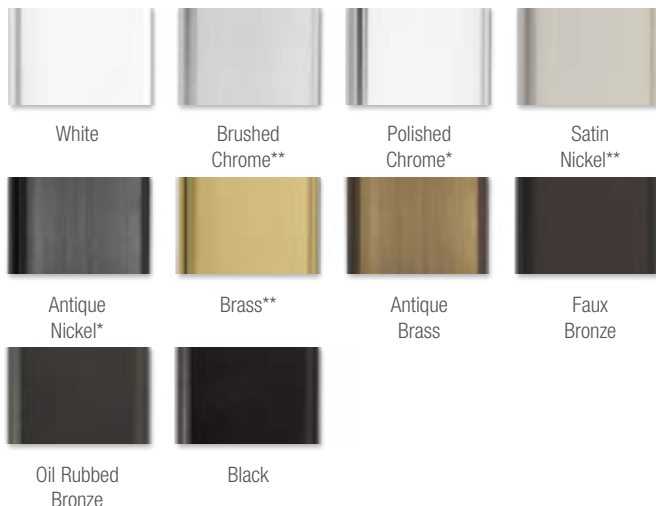

## Patio Door Stiles

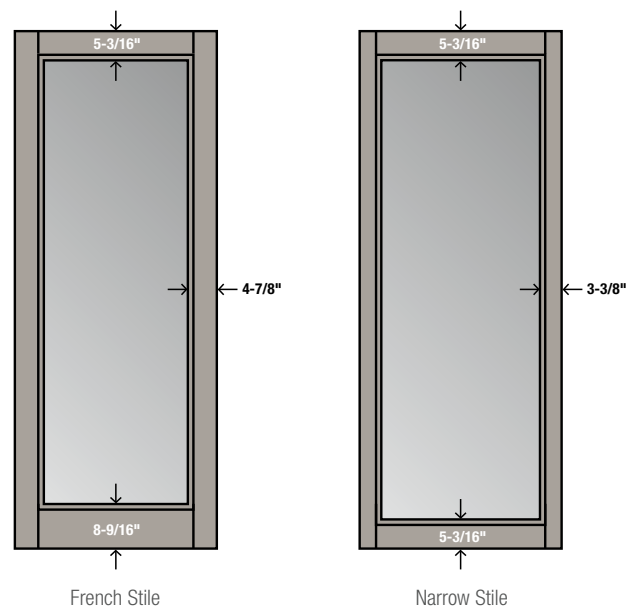

**NOTE:** Printing limitations prevent exact color/finish representation. See your Windsor distributor for actual samples.

# Pinnacle Select Options & Accessories\*

## Interior Finishes

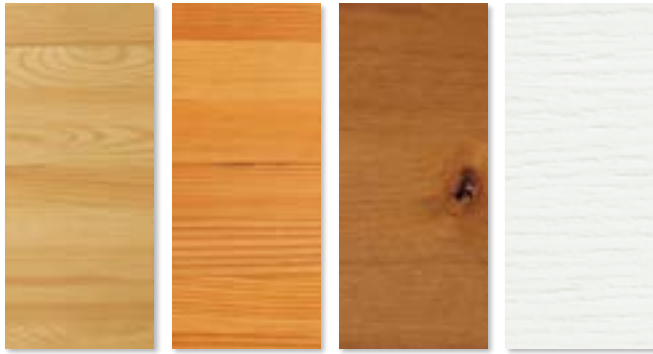

Clear Select Pine    Douglas Fir    Natural Alder    Primed

## Clad Exterior Trim



WM 180 Brickmould    Williamsburg    3-1/2" Flat  
3/8" Subsill    1-1/4" Subsill    2-1/4" Subsill

## Operating (Crank) Hardware and Finishes



Champagne    White    Bronze    Black    Faux Bronze



Oil Rubbed Bronze    Satin Nickel    Bright Brass

## Push-out (Lever) Hardware and Finishes



White    Black    Faux Bronze    Oil Rubbed Bronze    Satin Nickel

## Retractable Screens

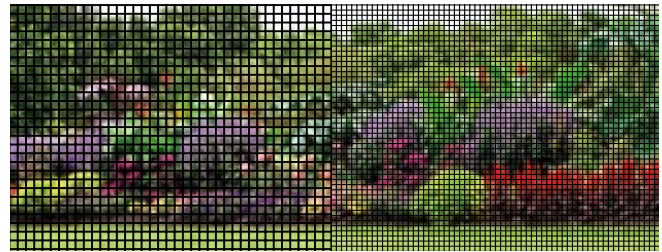

Conventional Screen Mesh    BetterVue®

Windsor's standard BetterVue screen material provides improved visibility, airflow and insect resistance.

Operating units are available with a standard screen or a retractable screen option. Standard screens are pressure mounted to fit within the frame of the window and are easily installed and removed.

Push-out casements and awnings are available with a retractable screen.

Retractable screens are available in pine, alder and fir wood species and have a solid wood pull at the bottom of the screen for easy operation. These spring-loaded units pull down from the top and lock into place at the sill. All interior tracks and covers come standard with species matched wood veneer.

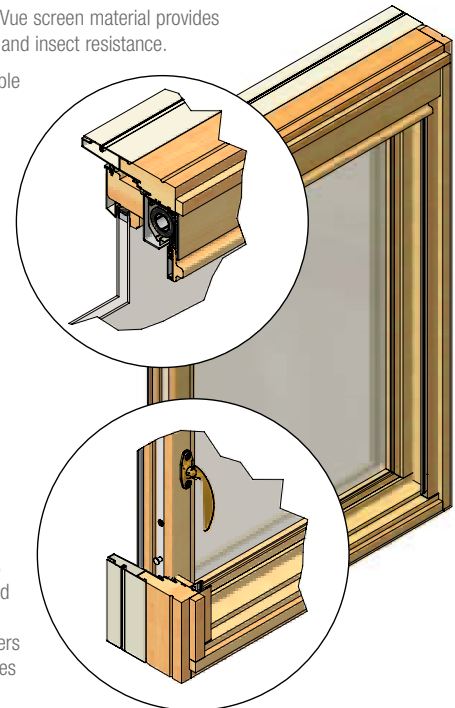

\*Pinnacle Select utilizes the same standard colors, feature colors, anodized finishes, glass and grilles as standard Pinnacle products. (See pages 16-22 for options.)

NOTE: Printing limitations prevent exact color/finish representation. See your Windsor distributor for actual samples.



# Pinnacle Select

## Casement, Awning & Picture

ROUGH	1-6 3/4	1-8 3/4	2-0 3/4	2-4 3/4	2-6 3/4	2-8 3/4	3-0 3/4	3-6 3/4	4-0 3/4	4-6 3/4	5-0 3/4	6-0 3/4
FRAME	1-6	1-8	2-0	2-4	2-6	2-8	3-0	3-6	4-0	4-6	5-0	6-0
GLASS	12 3/4	14 3/4	18 3/4	22 3/4	24 3/4	26 3/4	30 3/4	36 3/4	42 3/4	48 3/4	54 3/4	66 3/4
1-6 1/2												
1-8 1/2												
2-0 1/2												
2-6 1/2												
3-0 1/2												
3-6 1/2												
4-0 1/2												
4-6 1/2												
5-0 1/2												
5-6 1/2												
6-0 1/2												
6-6 1/2												
7-0 1/2												
7-6 1/2												
8-0 1/2												

1824	2024	2424	2824	3024	3224	3624	4224	4824	5424	6024		
1830	2030	2430	2830	3030	3230	3630	4230**	4830	5430	6030		
1836	2036	2436	2836	3036	3236	3636	4236**	4836	5436	6036	7236	
1842	2042	2442	2842	3042*	3242	3642	4242**	4842	5442	6042	7242	
1848	2048	2448	2848*	3048	3248	3648	4248**	4848	5444	6048	7248	
1854	2054	2454	2854*	3054	3254	3654	4254**	4854	5454	6054	7254	
1860	2060	2460	2860*	3060	3260	3660	4260**	4860	5460	6060	7260	
1866	2066	2466	2866*	3066	3266	3666	4266**	4866	5466	6066	7266	
1872	2072	2472	2872*	3072	3272	3672	4272	4872	5472	6072	7272	
1878	2078	2478	2878*	3078	3278	3678	4278	4878	5478	6078	7278	
1884**	2084**	2484**	2884**	3084**	3284	3684	4284	4884	5484	6084	7284	
1890**	2090**	2490**	2890**	3090**	3290	3690	4290	4890	5490	6090	7290	
1896**	2096**	2496**	2896**	3096**	3296	3696	4296	4896	5496	6096	7296	

Operating Casement Sizes   
  Operating Awning Sizes   
 \*Requires egress hardware to meet egress requirements   
 \*\*Crank-out only  
 Triple IG option only available up to 3678 on operating and push-out, 7278 on picture and 4836 on awning units.  
 Shaded units meet most egress requirements of 5.70 sq. ft. (Casement only). Verify state and local requirements with your local building inspector.

For clad brickmould applications, add 3/8" to rough opening width and height. **All sizes and specifications subject to change without notice.**



# Pinnacle Select

## Technical Drawings

Casement Operating with Standard Screen

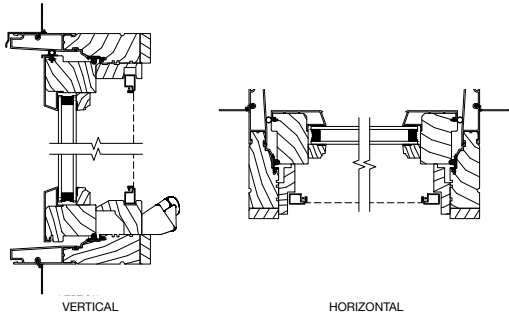

Awning Operating with Standard Screen

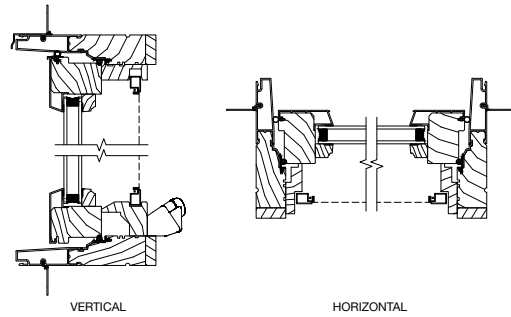

Triple IG Casement Operating with Standard Screen

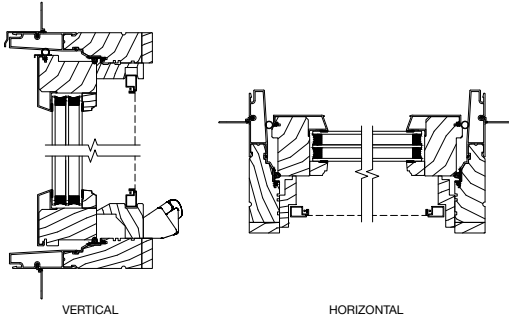

Triple IG Awning Operating with Standard Screen

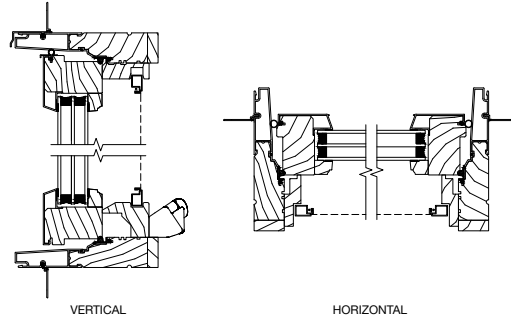

Casement Operating with Retractable Screen

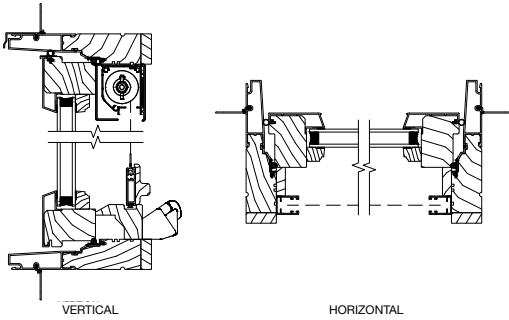

Awning Operating with Retractable Screen

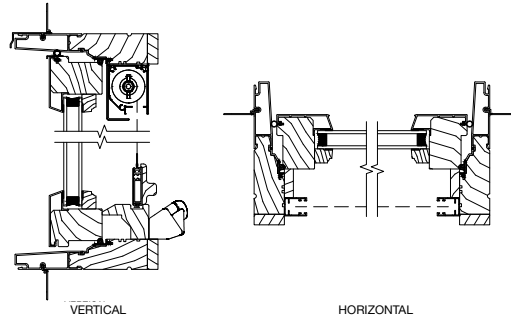

Triple IG Casement Operating with Retractable Screen

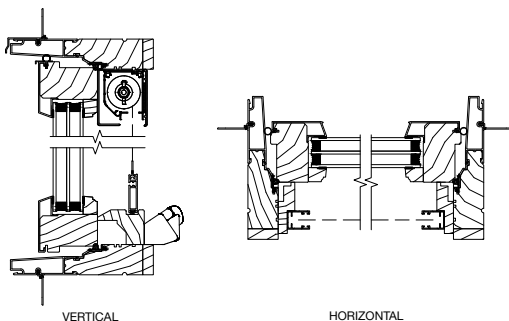

Triple IG Awning Operating with Retractable Screen

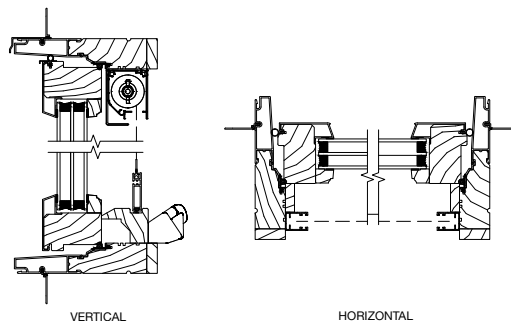



# Pinnacle Select

## Technical Drawings

Casement Push-out with No Screen

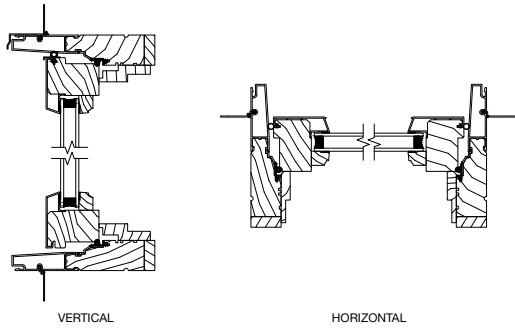

Awning Push-out with No Screen

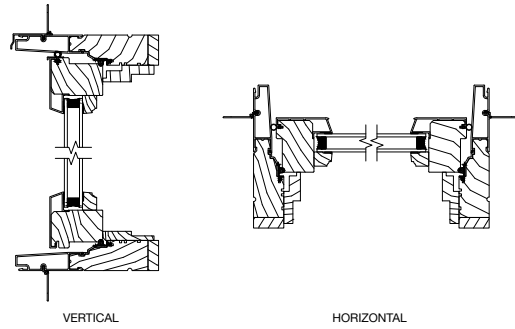

Triple IG Casement Push-out with No Screen

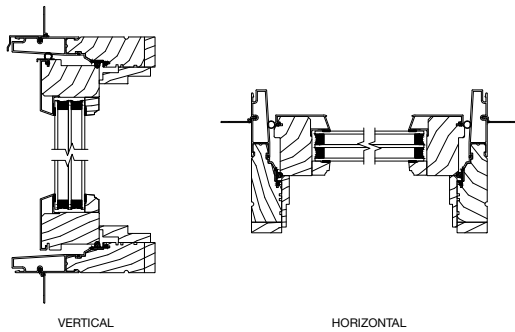

Triple IG Awning Push-out with No Screen

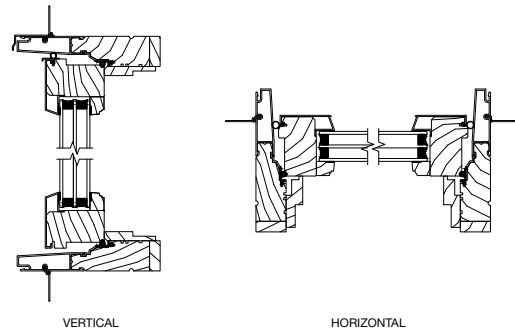

Casement Push-out with Retractable Screen

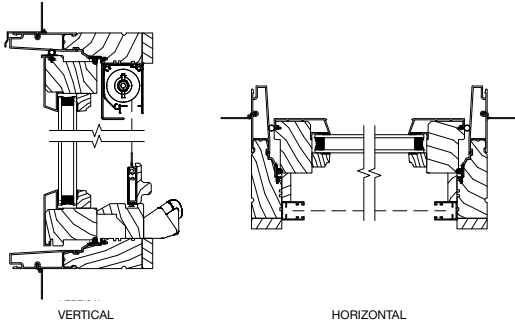

Awning Push-out with Retractable Screen

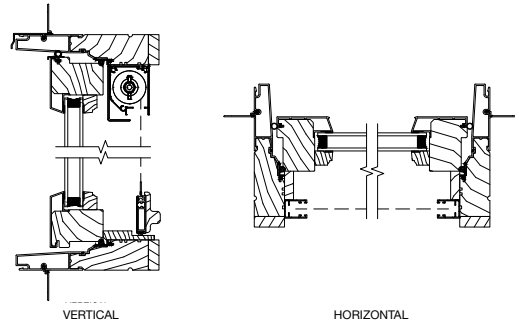

Triple IG Casement Push-out with Retractable Screen

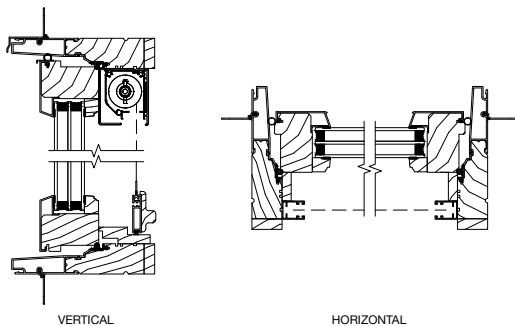

Triple IG Awning Push-out with Retractable Screen

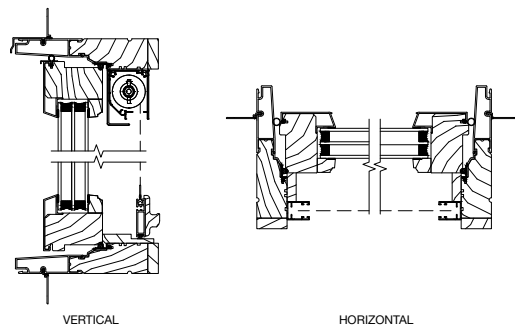

# Pinnacle

## Casement, Awning & Picture

### Pinnacle and Pinnacle Clad 3-1/4" Frame

ROUGH	1-6 3/4	1-8 3/4	2-0 3/4	2-4 3/4	2-6 3/4	2-8 3/4	3-0 3/4	3-6 3/4	4-0 3/4	4-6 3/4	5-0 3/4	6-0 3/4
FRAME	1-6	1-8	2-0	2-4	2-6	2-8	3-0	3-6	4-0	4-6	5-0	6-0
GLASS	14	16	20	24	26	28	32	38	44	50	56	68
1-6 1/2												
1-8 1/2												
2-0 1/2												
2-6 1/2												
3-0 1/2												
3-6 1/2												
4-0 1/2												
4-6 1/2												
5-0 1/2												
5-6 1/2												
6-0 1/2												
6-6 1/2												
7-0 1/2												
1420	1620	2020	2420	2620	2820	3220	3820	4420	5020	5620		
1426	1626	2026	2426	2626	2826	3226	3826	4426	5026	5626		
1432	1632	2032	2432	2632	2832	3232	3832	4432	5032	5632	6832	
1438	1638	2038	2438	2638*	2838	3238	3838	4438	5038	5638	6838	
1444	1644	2044	2444*	2644	2844	3244	3844	4444	5044	5644	6844	
1450	1650	2050	2450*	2650	2850	3250	3850	4450	5050	5650	6850	
1456	1656	2056	2456*	2656	2856	3256	3856	4456	5056	5656	6856	
1462	1662	2062	2462*	2662	2862	3262	3862	4462	5062	5662	6862	
1468	1668	2068	2468*	2668	2868	3268	3868	4468	5068	5668	6868	
1474	1674	2074	2474*	2674	2874	3274	3874	4474	5074	5674	6874	
1480	1680	2080	2480*	2680	2880	3280	3880	4480	5080	5680	6880	

— Operating Casement Sizes    - - - - - Operating Awning Sizes    \*Requires egress hardware to meet egress requirements  
 Shaded units meet most egress requirements of 5.70 sq. ft. (Casement only). Verify state and local requirements with your local building inspector.

For clad brickmould applications, add 3/8" to rough opening width and height. **All sizes and specifications subject to change without notice.**



## Pinnacle

# Casement In-sash Radius Round Top

ROUGH	4-0 3/4
FRAME	4-0
GLASS	20

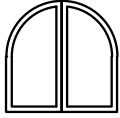
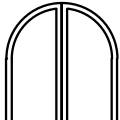
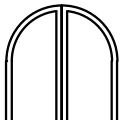
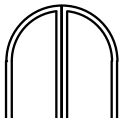
4-1 1/4	2-0/4-0	44		2020/44-2
4-7 1/4	2-6/4-6	50		2026/50-2
5-1 1/4	3-0/5-0	56		2032/56-2
5-7 1/4	3-6/5-6	62		2038/62-2

ROUGH	4-8 3/4
FRAME	4-8
GLASS	24

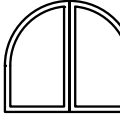
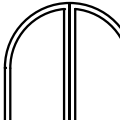
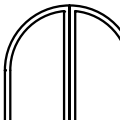
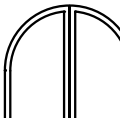
4-1 1/4	1-8/4-0	43		2416/44-2
4-7 1/4	2-2/4-6	49		2422/50-2
5-1 1/4	2-8/5-0	55		2428/56-2
5-7 1/4	3-2/5-6	61		2434/62-2

ROUGH	5-0 3/4
FRAME	5-0
GLASS	26

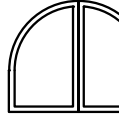
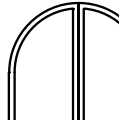
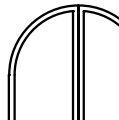
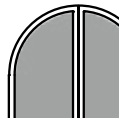
4-1 1/4	1-6/4-0	43		2614/44-2
4-7 1/4	2-0/4-6	49		2620/50-2
5-1 1/4	2-6/5-0	55		2626/56-2
5-7 1/4	3-0/5-6	61		2632/62-2

Shaded units meet most egress requirements of 5.70 sq. ft. Verify state and local requirements with your local building inspector.

Round top frame heights are shown as two numbers. The first number is the vertical leg height and the second number is the overall frame height. For clad brickmould applications, add 3/8" to rough opening width and height. **All sizes and specifications subject to change without notice.**

# Pinnacle

## Casement In-sash Radius Segment Top

### Single Radius

ROUGH	1-8 3/4	2-0 3/4	2-4 3/4	2-6 3/4	2-8 3/4	3-0 3/4
FRAME	1-8	2-0	2-4	2-6	2-8	3-0
GLASS	16	20	24	26	28	32
1-6 1/2 1-0/1-6 14	1608/14	2008/14	2408/14	2608/14	2808/14	3208/14
2-0 1/2 1-6/2-0 20	1614/20	2014/20	2414/20	2614/20	2814/20	3214/20
2-6 1/2 2-0/2-6 26	1620/26	2020/26	2420/26	2620/26	2820/26	3220/26
3-0 1/2 2-6/3-0 32	1626/32	2026/32	2426/32	2626/32	2826/32	3226/32
3-6 1/2 3-0/3-6 38	1632/38	2032/38	2432/38	2632/38	2832/38	3232/38
4-0 1/2 3-6/4-0 44	1638/44	2038/44	2438/44	2638/44	2838/44	3238/44
4-6 1/2 4-0/4-6 50	1644/50	2044/50	2444/50	2644/50	2844/50	3244/50
5-0 1/2 4-6/5-0 56	1650/56	2050/56	2450/56	2650/56	2850/56	3250/56
5-6 1/2 5-0/5-6 62	1656/62	2056/62	2456/62	2656/62	2856/62	3256/62
6-0 1/2 5-6/6-0 68	1662/68	2062/68	2462/68	2662/68	2862/68	3262/68

----- Operating Sizes

Shaded units meet most egress requirements of 5.70 sq. ft. Verify state and local requirements with your local building inspector.

Springline from vertical leg to top of radius is 6" on all segment top casement windows. For example, 3-6/4-0 means a vertical leg height of 3-6 and an overall height of 4-0. For clad brickmould applications, add 3/8" to rough opening width and height. **All sizes and specifications subject to change without notice.**



# Pinnacle

## Casement In-sash Radius Segment Top

### Two-wide Radius

ROUGH	3-4 3/4	4-0 3/4	4-8 3/4	5-0 3/4	5-4 3/4	6-0 3/4
FRAME	3-4	4-0	4-8	5-0	5-4	6-0
GLASS	16	20	24	26	28	32
1-6 1/2 1-0/1-6 14	 1608/14-2	 2008/14-2	 2408/14-2	 2608/14-2	 2808/14-2	 3208/14-2
2-0 1/2 1-6/2-0 20	 1614/20-2	 2014/20-2	 2414/20-2	 2614/20-2	 2814/20-2	 3214/20-2
2-6 1/2 2-0/2-6 26	 1620/26-2	 2020/26-2	 2420/26-2	 2620/26-2	 2820/26-2	 3220/26-2
3-0 1/2 2-6/3-0 32	 1626/32-2	 2026/32-2	 2426/32-2	 2626/32-2	 2826/32-2	 3226/32-2
3-6 1/2 3-0/3-6 38	 1632/38-2	 2032/38-2	 2432/38-2	 2632/38-2	 2832/38-2	 3232/38-2
4-0 1/2 3-6/4-0 44	 1638/44-2	 2038/44-2	 2438/44-2	 2638/44-2	 2838/44-2	 3238/44-2
4-6 1/2 4-0/4-6 50	 1644/50-2	 2044/50-2	 2444/50-2	 2644/50-2	 2844/50-2	 3244/50-2
5-0 1/2 4-6/5-0 56	 1650/56-2	 2050/56-2	 2450/56-2	 2650/56-2	 2850/56-2	 3250/56-2
5-6 1/2 5-0/5-6 62	 1656/62-2	 2056/62-2	 2456/62-2	 2656/62-2	 2856/62-2	 3256/62-2
6-0 1/2 5-6/6-0 68	 1662/68-2	 2062/68-2	 2462/68-2	 2662/68-2	 2862/68-2	 3262/68-2

----- Operating Sizes

Shaded units meet most egress requirements of 5.70 sq. ft. Verify state and local requirements with your local building inspector.

Springline from vertical leg to top of radius is 6" on all segment top casement windows. For example, 3-6/4-0 means a vertical leg height of 3-6 and an overall height of 4-0. For clad brickmould applications, add 3/8" to rough opening width and height. **All sizes and specifications subject to change without notice.**



# Pinnacle

## Casement In-sash Radius Segment Top

### Three-wide Radius

ROUGH	5-0 3/4	6-0 3/4	7-0 3/4	7-6 3/4	8-0 3/4	9-0 3/4
FRAME	5-0	6-0	7-0	7-6	8-0	9-0
GLASS	16	20	24	26	28	32
1-6 1/2 1-0 1/4-6 14	1608/14-3	2008/14-3	2408/14-3	2608/14-3	2808/14-3	3208/14-3
2-0 1/2 1-6 1/2-0 20	1614/20-3	2014/20-3	2414/20-3	2614/20-3	2814/20-3	3214/20-3
2-6 1/2 2-0 1/2-6 26	1620/26-3	2020/26-3	2420/26-3	2620/26-3	2820/26-3	3220/26-3
3-0 1/2 2-6 3/4-0 32	1626/32-3	2026/32-3	2426/32-3	2626/32-3	2826/32-3	3226/32-3
3-6 1/2 3-0 3/4-6 38	1632/38-3	2032/38-3	2432/38-3	2632/38-3	2832/38-3	3232/38-3
4-0 1/2 3-6 1/4-0 44	1638/44-3	2038/44-3	2438/44-3	2638/44-3	2838/44-3	3238/44-3
4-6 1/2 4-0 1/4-6 50	1644/50-3	2044/50-3	2444/50-3	2644/50-3	2844/50-3	3244/50-3
5-0 1/2 4-6 1/5-0 56	1650/56-3	2050/56-3	2450/56-3	2650/56-3	2850/56-3	3250/56-3
5-6 1/2 5-0 1/5-6 62	1656/62-3	2056/62-3	2456/62-3	2656/62-3	2856/62-3	3256/62-3
6-0 1/2 5-6 1/5-0 68	1662/68-3	2062/68-3	2462/68-3	2662/68-3	2862/68-3	3262/68-3

----- Operating Sizes

Shaded units meet most egress requirements of 5.70 sq. ft. Verify state and local requirements with your local building inspector.

Springline from vertical leg to top of radius is 6" on all segment top casement windows. For example, 3-6/4-0 means a vertical leg height of 3-6 and an overall height of 4-0. For clad brickmould applications, add 3/8" to rough opening width and height. **All sizes and specifications subject to change without notice.**

# Pinnacle

## Casement In-sash Radius Segment Top

### Four-wide Radius

ROUGH	6-8 3/4	8-0 3/4	9-4 3/4	10-0 3/4	10-8 3/4	12-0 3/4
FRAME	6-8	8-0	9-4	10-0	10-8	12-0
GLASS	16	20	24	26	28	32
1-6 1/2 1-0/1-6 14						
2-0 1/2 1-6/2-0 20						
2-6 1/2 2-0/2-6 26						
3-0 1/2 2-6/3-0 32						
3-6 1/2 3-0/3-6 38						
4-0 1/2 3-6/4-0 44						
4-6 1/2 4-0/4-6 50						
5-0 1/2 4-6/5-0 56						
5-6 1/2 5-0/5-6 62						
6-0 1/2 5-6/6-0 68						

----- Operating Sizes

Shaded units meet most egress requirements of 5.70 sq. ft. Verify state and local requirements with your local building inspector.















































Springline from vertical leg to top of radius is 6" on all segment top casement windows. For example, 3-6/4-0 means a vertical leg height of 3-6 and an overall height of 4-0. For clad brickmould applications, add 3/8" to rough opening width and height. **All sizes and specifications subject to change without notice.**



# Pinnacle

## Casement Transom

### Pinnacle and Pinnacle Clad 3-1/4" Frame









































MAS. OPG. PRIMED	1-9 9/16	1-11 9/16	2-3 9/16	2-7 9/16	2-9 9/16	2-11 9/16	3-3 9/16					
MAS. OPG. CLAD	1-6 3/4	1-8 3/4	2-0 3/4	2-4 3/4	2-6 3/4	2-8 3/4	3-0 3/4					
ROUGH PRIMED	1-6 3/4	1-8 3/4	2-0 3/4	2-4 3/4	2-6 3/4	2-8 3/4	3-0 3/4					
ROUGH CLAD	1-6 3/4	1-8 3/4	2-0 3/4	2-4 3/4	2-6 3/4	2-8 3/4	3-0 3/4					
FRAME	1-6	1-8	2-0	2-4	2-6	2-8	3-0					
GLASS	14	16	20	24	26	28	32					
1-2 15/16	1-0 1/2	1-1 1/4	1-0 1/2	1-0	8							
1-4 15/16	1-2 1/2	1-3 1/4	1-2 1/2	1-2	10							
1-6 15/16	1-4 1/2	1-5 1/4	1-4 1/2	1-4	12							
1-8 15/16	1-6 1/2	1-7 1/4	1-6 1/2	1-6	14							
1-10 15/16	1-8 1/2	1-9 1/4	1-8 1/2	1-8	16							
2-2 15/16	2-0 1/2	2-1 1/4	2-0 1/2	2-0	20							
2-6 15/16	2-4 1/2	2-5 1/4	2-4 1/2	2-4	24							
2-8 15/16	2-6 1/2	2-7 1/4	2-6 1/2	2-6	26							



# Pinnacle

## Casement Transom

### Pinnacle and Pinnacle Clad 3-1/4" Frame

MAS. OPG. PRIMED	3-9 9/16	4-3 9/16	4-9 9/16	5-3 9/16	6-3 9/16					
MAS. OPG. CLAD	3-6 3/4	4-0 3/4	4-6 3/4	5-0 3/4	6-0 3/4					
ROUGH PRIMED	3-6 3/4	4-0 3/4	4-6 3/4	5-0 3/4	6-0 3/4					
ROUGH CLAD	3-6 3/4	4-0 3/4	4-6 3/4	5-0 3/4	6-0 3/4					
FRAME	3-6	4-0	4-6	5-0	6-0					
GLASS	38	44	50	56	68					
1-2 15/16	1-0 1/2	1-1 1/4	1-0 1/2	1-0	8	 3808	 4408	 5008	 5608	 6808
1-4 15/16	1-2 1/2	1-3 1/4	1-2 1/2	1-2	10	 3810	 4410	 5010	 5610	 6810
1-6 15/16	1-4 1/2	1-5 1/4	1-4 1/2	1-4	12	 3812	 4412	 5012	 5612	 6812
1-8 15/16	1-6 1/2	1-7 1/4	1-6 1/2	1-6	14	 3814	 4414	 5014	 5614	 6814
1-10 15/16	1-8 1/2	1-9 1/4	1-8 1/2	1-8	16	 3816	 4416	 5016	 5616	 6816
2-2 15/16	2-0 1/2	2-1 1/4	2-0 1/2	2-0	20	 3820	 4420	 5020	 5620	 6820
2-6 15/16	2-4 1/2	2-5 1/4	2-4 1/2	2-4	24	 3824	 4424	 5024	 5624	 6824
2-8 15/16	2-6 1/2	2-7 1/4	2-6 1/2	2-6	26	 3826	 4426	 5026	 5626	 6826

All sizes and specifications subject to change without notice.

# Pinnacle Clad Casement & Awning Technical Drawings

Pinnacle Clad Casement – Operating

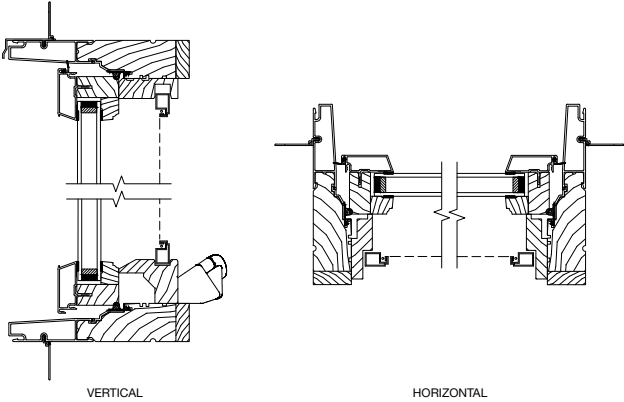

Pinnacle Clad Awning – Operating

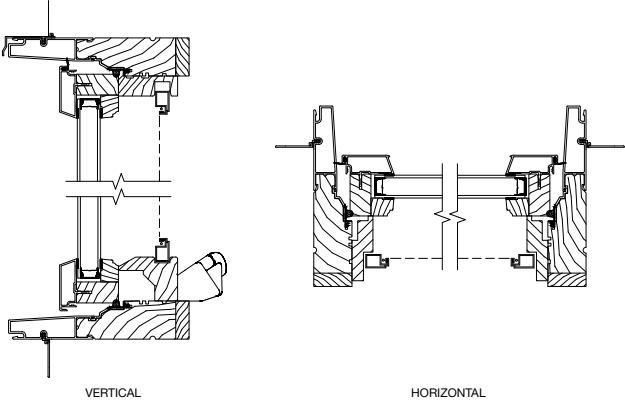

Pinnacle Clad Casement – Stationary

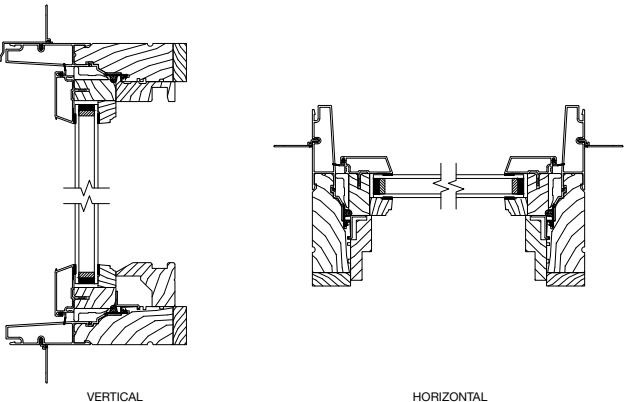

Pinnacle Clad Awning – Stationary

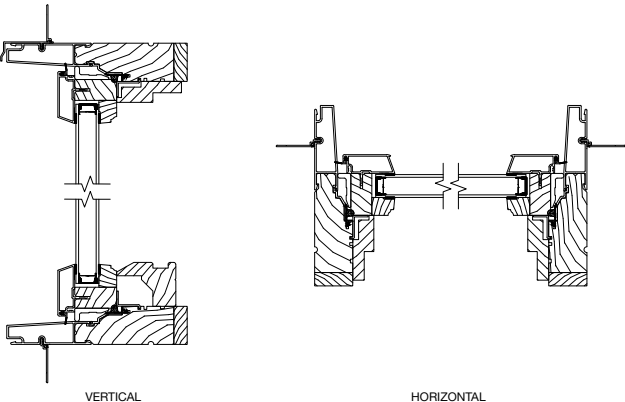

Pinnacle Clad Casement – Transom and Picture

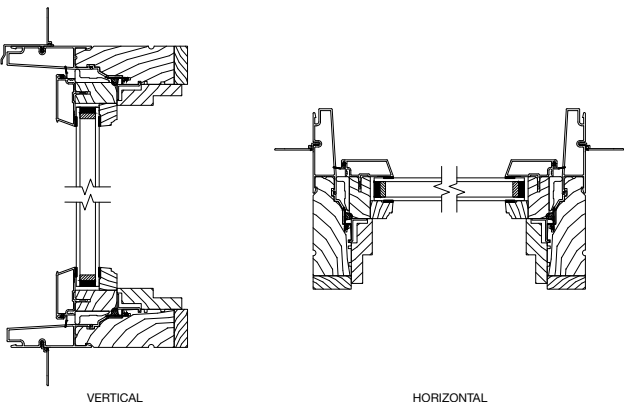

# Pinnacle Clad Casement & Awning with 3-1/4" Frame Technical Drawings

Pinnacle Clad Casement with 3-1/4" Frame – Operating

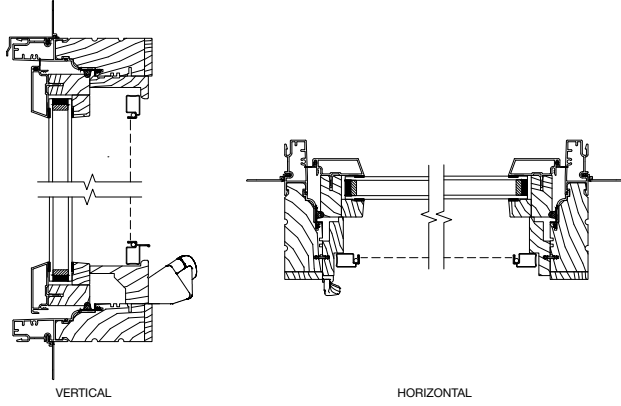

Pinnacle Clad Awning with 3-1/4" Frame – Operating

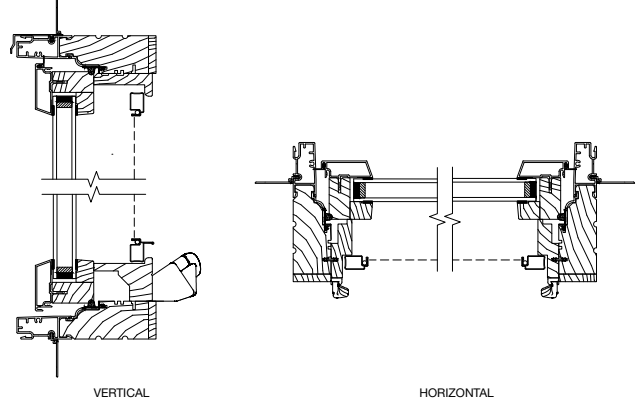

Pinnacle Clad Casement with 3-1/4" Frame – Stationary

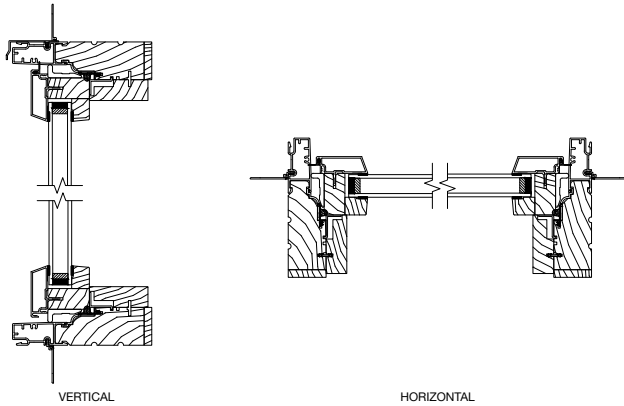

Pinnacle Clad Awning with 3-1/4" Frame – Stationary

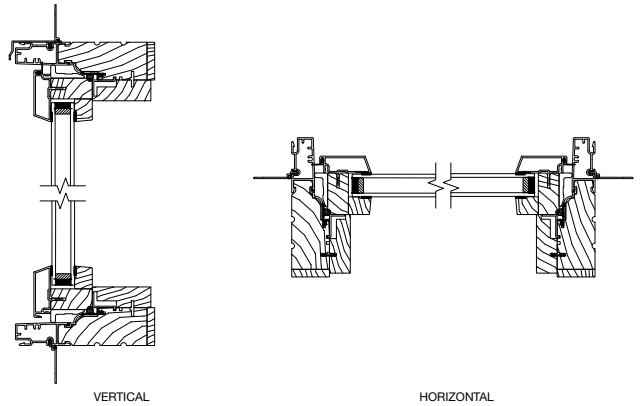

Pinnacle Clad Casement with 3-1/4" Frame –  
Transom and Picture

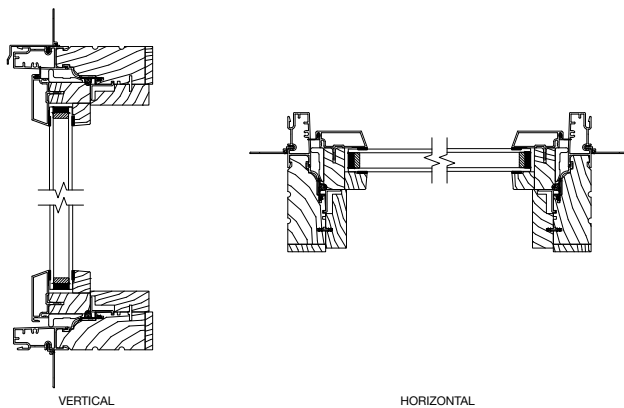



# Pinnacle Primed Casement & Awning Technical Drawings

Pinnacle Primed Casement – Operating

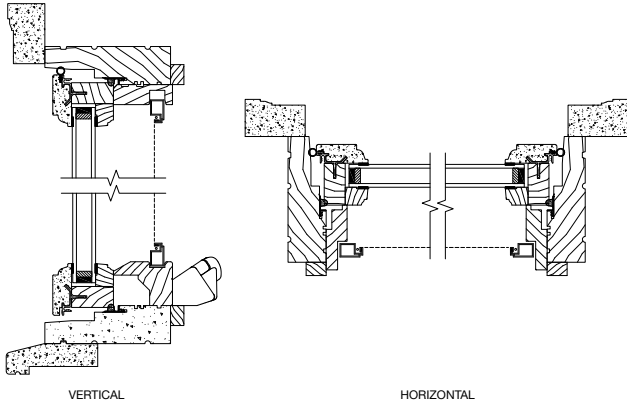

Pinnacle Primed Awning – Operating

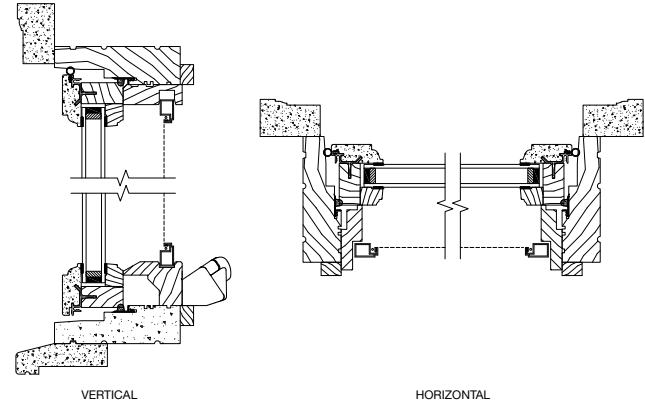

Pinnacle Primed Casement – Stationary

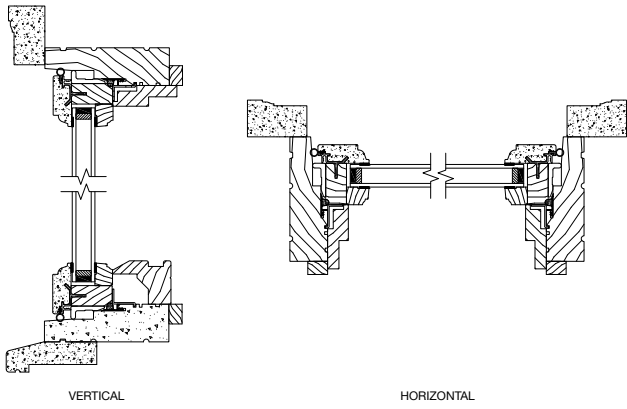

Pinnacle Primed Awning – Stationary

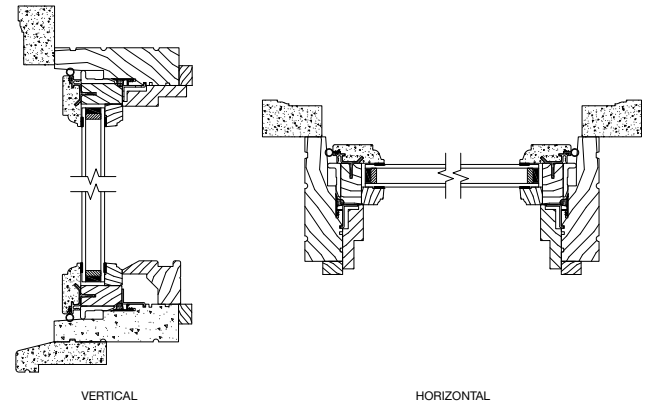

Pinnacle Primed Casement – Transom and Picture

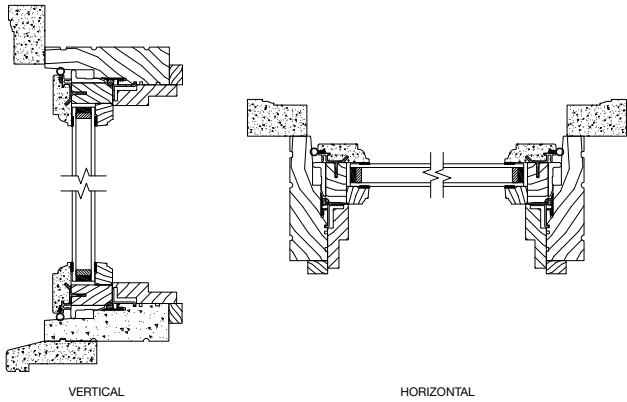

# Pinnacle Double Hung

ROUGH FRAME CLASS	1-10 1/8 1-9 3/8 16	2-2 1/8 2-1 3/8 20	2-6 1/8 2-5 3/8 24	2-8 1/8 2-7 3/8 26	2-10 1/8 2-9 3/8 28	3-0 1/8 2-11 3/8 30	3-2 1/8 3-1 3/8 32	3-6 1/8 3-5 3/8 36	3-10 1/8 3-9 3/8 40	4-0 1/8 3-11 3/8 42
3-1 1/4 3-0 3/4 14-14	1614	2014	2414	2614	2814	3014	3214	3614	4014	4214
3-5 1/4 3-4 3/4 18-18	1616	2016	2416	2616	2816	3016	3216	3616	4016	4216
4-1 1/4 4-0 3/4 20-20	1620	2020	2420	2620	2820	3020	3220	3620	4020	4220
4-5 1/4 4-4 3/4 22-22	1622	2022	2422	2622	2822	3022	3222	3622	4022	4222
4-9 1/4 4-8 3/4 24-24	1624	2024	2424	2624	2824	3024	3224	3624	4024	4224
5-1 1/4 5-0 3/4 26-26	1626	2026	2426	2626	2826	3026	3226	3626	4026	4226
5-5 1/4 5-4 3/4 28-28	1628	2028	2428	2628	2828	3028	3228	3628	4028	4228
5-9 1/4 5-8 3/4 30-30	1630	2030	2430	2630	2830	3030	3230	3630	4030	4230
6-1 1/4 6-0 3/4 32-32	1632	2032	2432	2632	2832	3032	3232	3632	4032	4232
6-5 1/4 6-4 3/4 34-34	1634	2034	2434	2634	2834	3034	3234	3634	4034	4234
6-9 1/4 6-8 3/4 36-36	1636	2036	2436	2636	2836	3036	3236	3636	4036	4236
7-1 1/4 7-0 3/4 38-38	1638	2038	2438	2638	2838	3038	3238	3638	4038*	4238*
7-5 1/4 7-4 3/4 40-40	1640	2040	2440	2640	2840	3040	3240	3640	4040*	4240*
7-9 1/4 7-8 3/4 42-42	1642	2042	2442	2642	2842	3042	3242	3642	4042*	4242*
8-1 1/4 8-0 3/4 44-44	1644	2044	2444	2644	2844	3044	3244	3644	4044*	4244*

----- Clad and Concealed Jambliner only \*Clad only  
 Shaded units meet most egress requirements of 5.70 sq. ft. Verify state and local requirements with your local building inspector.

Windsor double hungs can be clad or primed and these charts are applicable for both. For clad brickmould applications, add 3/8" to rough opening width and height. **All sizes and specifications subject to change without notice.**



# Pinnacle

## Double Hung Picture

ROUGH	1-2 1/8	1-4 1/8	1-6 1/8	2-2 1/8	2-6 1/8	2-8 1/8	2-10 1/8	3-2 1/8	4-2 1/8	5-2 1/8	6-1 3/8
FRAME	1-1 3/8	1-3 3/8	1-5 3/8	2-1 3/8	2-5 3/8	2-7 3/8	2-9 3/8	3-1 3/8	4-1 3/8	5-1 3/8	6-2 1/8
GLASS	8	10	12	20	24	26	28	32	44	56	68
4-1 1/4	0842	1042	1242	2042	2442	2642	2842	3242	4442	5642	6842
4-0 3/4	0846	1046	1246	2046	2446	2646	2846	3246	4446	5646	6846
4-5 1/4	0850	1050	1250	2050	2450	2650	2850	3250	4450	5650	6850
4-4 3/4	0854	1054	1254	2054	2454	2654	2854	3254	4454	5654	6854
4-1 1/2	0858	1058	1258	2058	2458	2658	2858	3258	4458	5658	6858
5-1 1/4	0862	1062	1262	2062	2462	2662	2862	3262	4462	5662	6862
5-0 3/4	0866	1066	1266	2066	2466	2666	2866	3266	4466	5666	6866
5-1 1/2	0870	1070	1270	2070	2470	2670	2870	3270	4470	5670	6870
5-5 1/4	0874	1074	1274	2074	2474	2674	2874	3274	4474		
5-4 3/4	0878	1078	1278	2078	2478	2678	2878	3278	4478		
5-1 1/2	0882	1082	1282	2082	2482	2682	2882	3282	4482		
6-1 1/4	0886	1086	1286	2086	2486	2686	2886	3286	4486		
6-0 3/4	0890	1090	1290	2090	2490	2690	2890	3290	4490		























































































Windsor double hungs can be clad or primed and these charts are applicable for both. For clad brickmould applications, add 3/8" to rough opening width and height. **All sizes and specifications subject to change without notice.**



# Pinnacle

## Double Hung Transom

### Clad (In-sash)

MAS. OPG. CLAD	1-10 1/8	2-2 1/8	2-6 1/8	2-8 1/8	2-10 1/8	3-0 1/8	3-2 1/8	3-6 1/8	3-10 1/8	4-0 1/8	4-2 1/8	5-2 1/8
ROUGH	1-10 1/8	2-2 1/8	2-6 1/8	2-8 1/8	2-10 1/8	3-0 1/8	3-2 1/8	3-6 1/8	3-10 1/8	4-0 1/8	4-2 1/8	5-2 1/8
FRAME	1-9 3/8	2-1 3/8	2-5 3/8	2-7 3/8	2-9 3/8	2-11 3/8	3-1 3/8	3-5 3/8	3-9 3/8	3-11 3/8	4-1 3/8	5-1 3/8
GLASS	17 3/8	21 3/8	25 3/8	27 3/8	29 3/8	31 3/8	33 3/8	37 3/8	41 3/8	43 3/8	45 3/8	57 3/8
1-0 1/2												
1-0	1608	2008	2408	2608	2808	3008	3208	3608	4008	4208	4408	5608
1-2 1/2												
1-2	1610	2010	2410	2610	2810	3010	3210	3610	4010	4210	4410	5610
1-4 1/2												
1-4	1612	2012	2412	2612	2812	3012	3212	3612	4012	4212	4412	5612
1-6 1/2												
1-6	1614	2014	2414	2614	2814	3014	3214	3614	4014	4214	4414	5614
2-0 1/2												
2-0	1620	2020	2420	2620	2820	3020	3220	3620	4020	4220	4420	5620
2-6 1/2												
2-6	1626	2026	2426	2626	2826	3026	3226	3626	4026	4226	4426	5626
3-0 1/2												
3-0	1632	2032	2432	2632	2832	3032	3232	3632	4032	4232	4432	5632

# Pinnacle

## Double Hung Transom

Primed (In-sash)

MAS. OPG. PRIMED	2-0 3/4	2-4 3/4	2-8 3/4	2-10 3/4	3-0 3/4	3-2 3/4	3-4 3/4	3-8 3/4	4-0 3/4	4-4 3/4	5-4 3/4	6-4 3/4
ROUGH	1-10 1/8	2-2 1/8	2-6 1/8	2-8 1/8	2-10 1/8	3-0 1/8	3-2 1/8	3-6 1/8	3-10 1/8	4-2 1/8	5-2 1/8	6-2 1/8
FRAME	1-9 3/8	2-1 3/8	2-5 3/8	2-7 3/8	2-9 3/8	2-11 3/8	3-1 3/8	3-5 3/8	3-9 3/8	4-1 3/8	5-1 3/8	6-1 3/8
GLASS	16	20	24	26	28	30	32	36	40	44	56	68
3-4 5/8 3-2 1/16 3-1 9/16	1608	2008	2408	2608	2808	3008	3208	3608	4008	4408	5608	6808
2-10 5/8 2-8 1/16 2-7 9/16	1610	2010	2410	2610	2810	3010	3210	3610	4010	4410	5610	6810
2-4 5/8 2-2 1/16 2-1 9/16	1612	2012	2412	2612	2812	3012	3212	3612	4012	4412	5612	6812
2-10 5/8 2-8 1/16 2-7 9/16	1614	2014	2414	2614	2814	3014	3214	3614	4014	4414	5614	6814
2-4 5/8 2-2 1/16 2-1 9/16	1620	2020	2420	2620	2820	3020	3220	3620	4020	4420	5620	6820
2-10 5/8 2-8 1/16 2-7 9/16	1626	2026	2426	2626	2826	3026	3226	3626	4026	4426	5626	6826
3-4 5/8 3-2 1/16 3-1 9/16	1632	2032	2432	2632	2832	3032	3232	3632	4032	4432	5632	6832

# Pinnacle Clad Glide-by

*Pinnacle glide-bys are available with clad exterior only.*

	ROUGH	3-3 15/16	3-11 15/16	4-7 15/16	4-11 15/16	5-3 15/16	5-11 15/16
	FRAME	3-3 3/16	3-11 3/16	4-7 3/16	4-11 3/16	5-3 3/16	5-11 3/16
	GLASS	16-16	20-20	24-24	26-26	28-28	32-32
1-11 1/4 1-10 3/4 16							
2-3 1/4 2-2 3/4 20							
2-11 1/4 2-10 3/4 28							
3-3 1/4 3-2 3/4 32							
3-7 1/4 3-6 3/4 36							
3-11 1/4 3-10 3/4 40							
4-7 1/4 4-6 3/4 48							
5-1 1/4 5-0 3/4 54							

# Pinnacle Triple Units

	ROUGH	6-1 7/16	7-5 7/16	7-9 7/16	8-9 7/16
	FRAME	6-0 11/16	7-4 11/16	7-8 11/16	8-8 11/16
	GLASS	16-32-16	20-40-20	28-28-28	24-48-24
2-11 1/4 2-10 3/4 28					
3-11 1/4 3-10 3/4 40					
4-7 1/4 4-6 3/4 48					
5-1 1/4 5-0 3/4 54					

Shaded units meet most egress requirements of 5.70 sq. ft. Verify state and local requirements with your local building inspector.

For clad brickmould applications, add 3/8" to rough opening width and height. **All sizes and specifications subject to change without notice.**



# Pinnacle Clad/Primed Double Hung & Glide-by Technical Drawings

Pinnacle Clad Double Hung – Operating

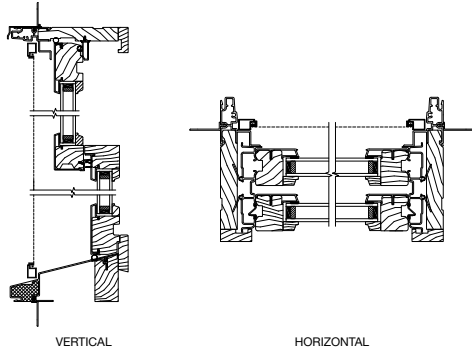

Pinnacle Clad Concealed Jambliner Double Hung – Operating

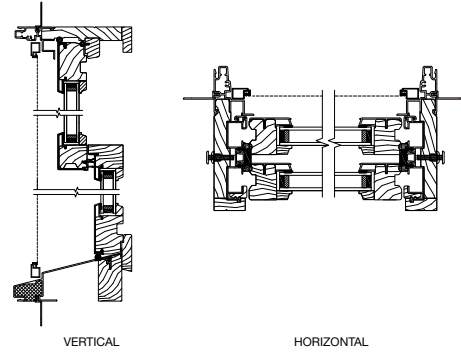

Pinnacle Clad Double Hung – Picture

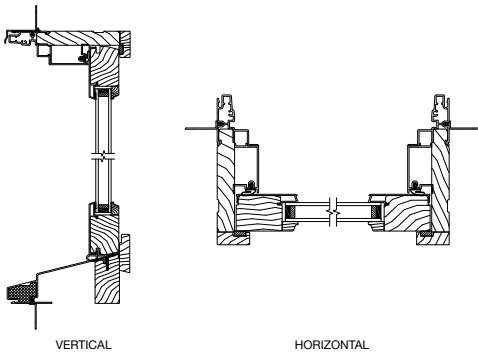

Pinnacle Clad Glide-by

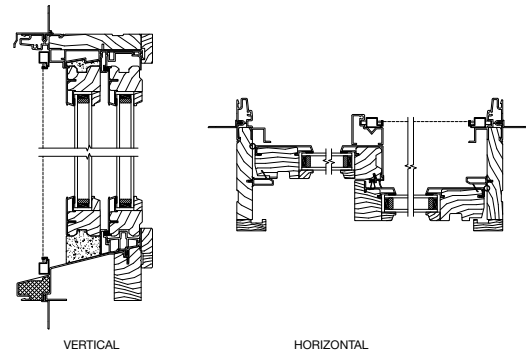

Pinnacle Clad Double Hung – Transom

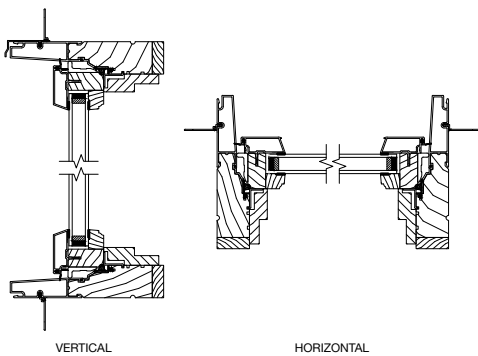

Pinnacle Primed Double Hung – Operating

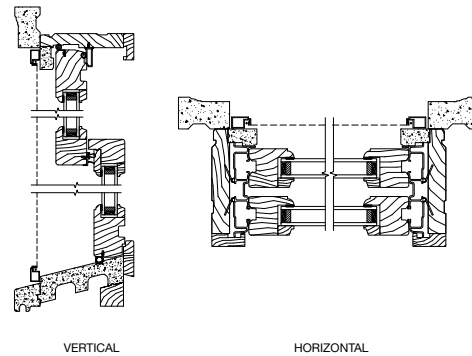

Pinnacle Primed Double Hung – Picture

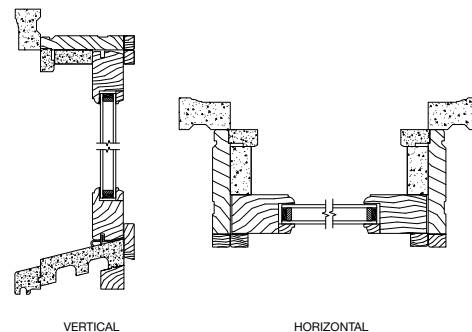

# Pinnacle

## Single Hung Radius Round Top

ROUGH		2-6 1/8		
FRAME		2-5 3/8		
GLASS		24		
5-5 3/8	5-4 7/8	22		2422
5-9 3/8	5-8 7/8	24		2424
6-1 3/8	6-0 7/8	26		2426
6-5 3/8	6-4 7/8	28		2428
6-9 3/8	6-8 7/8	30		2430
7-1 3/8	7-0 7/8	32		2432
7-5 3/8	7-4 7/8	34		2434
7-9 3/8	7-8 7/8	36		2436

ROUGH		2-10 1/8		
FRAME		2-9 3/8		
GLASS		28		
5-6 7/8	5-7 3/8	22		2822
5-10 7/8	5-11 3/8	24		2824
6-2 7/8	6-3 3/8	26		2826
6-6 7/8	6-7 3/8	28		2828
6-10 7/8	6-11 3/8	30		2830
7-2 7/8	7-3 3/8	32		2832
7-6 7/8	7-7 3/8	34		2834
7-10 7/8	7-11 3/8	36		2836

ROUGH		3-2 1/8		
FRAME		3-1 3/8		
GLASS		32		
5-8 7/8	5-9 3/8	22		3222
6-0 7/8	6-1 3/8	24		3224
6-4 7/8	6-5 3/8	26		3226
6-8 7/8	6-9 3/8	28		3228
7-0 7/8	7-1 3/8	30		3230
7-4 7/8	7-5 3/8	32		3232
7-8 7/8	7-9 3/8	34		3234
8-0 7/8	8-1 3/8	36		3236

































Shaded units meet most egress requirements of 5.70 sq. ft. Verify state and local requirements with your local building inspector.

For clad brickmould applications, add 3/8" to rough opening width and height.

**All sizes and specifications subject to change without notice.**

# Pinnacle

## Single Hung Radius Segment Top

ROUGH	2-6 1/8	2-10 1/8	3-2 1/8
FRAME	2-5 3/8	2-9 3/8	3-1 3/8
GLASS	24	28	32
4-9 1/16 4-8 9/16 22-25 31/32	 2422	 2822	 3222
5-1 1/16 5-0 9/16 24-27 31/32	 2424	 2824	 3224
5-5 1/16 5-4 9/16 26-29 31/32	 2426	 2826	 3226
5-9 1/16 5-8 9/16 28-31 31/32	 2428	 2828	 3228
6-1 1/16 6-0 9/16 30-33 31/32	 2430	 2830	 3230
6-5 1/16 6-4 9/16 32-35 31/32	 2432	 2832	 3232
6-9 1/16 6-8 9/16 34-37 31/32	 2434	 2834	 3234
7-1 1/16 7-0 9/16 36-39 31/32	 2436	 2836	 3236
7-5 1/16 7-4 9/16 38-41 31/32	 2438	 2838	 3238
7-9 1/16 7-8 9/16 40-43 31/32	 2440	 2840	 3240
8-1 1/16 8-0 9/16 42-45 31/32	 2442	 2842	 3242

Shaded units meet most egress requirements of 5.70 sq. ft. Verify state and local requirements with your local building inspector.

Springline from vertical leg to top of radius is 6" on all segment top casement windows. For example, 3-6/4-0 means a vertical leg height of 3-6 and an overall height of 4-0. For clad brickmould applications, add 3/8" to rough opening width and height. **All sizes and specifications subject to change without notice.**















# Pinnacle

## Direct Set Radius





### Casement

ROUGH		2-0 3/4	
FRAME		2-0	
GLASS		21 15/16	
1-0 1/2			
1-0	10		
		3-0 3/4	
		3-0	
		33 15/16	
1-6 1/2			
1-6	16		
		5-0 3/4	
		5-0	
		57 15/16	
2-6 1/2			
2-6	28		
		7-0 3/4	
		7-0	
		81 15/16	
3-6 1/2			
3-6	40		
		5-0 3/4	
		5-0	
		57 15/16	
2-6 1/2			
2-6	28		





  

ROUGH		2-4 3/4	
FRAME		2-4	
GLASS		25 15/16	
1-2 1/2			
1-2	12		
		3-4 3/4	
		3-4	
		37 15/16	
1-8 1/2			
1-8	18		
		4-8 3/4	
		4-8	
		53 15/16	
2-4 1/2			
2-4	26		
		7-8 3/4	
		7-8	
		87 15/16	
3-0 1/2			
3-0	43		
		6-0 3/4	
		6-0	
		69 15/16	
3-0 1/2			
3-0	34		





  

ROUGH		2-6 3/4	
FRAME		2-6	
GLASS		27 15/16	
1-3 1/2			
1-3	13		
		3-6 3/4	
		3-6	
		39 15/16	
1-9 1/2			
1-9	19		
		5-0 3/4	
		5-0	
		57 15/16	
2-6 1/2			
2-6	28		
		8-0 3/4	
		8-0	
		93 15/16	
4-0 1/2			
4-0	46		





  

ROUGH		2-8 3/4	
FRAME		2-8	
GLASS		29 15/16	
1-4 1/2			
1-4	14		
		4-0 3/4	
		4-0	
		45 15/16	
2-0 1/2			
2-0	22		
		5-4 3/4	
		5-4	
		61 15/16	
2-8 1/2			
2-8	30		
		9-0 3/4	
		9-0	
		105 15/16	
4-8 1/2			
4-8	52		





  

ROUGH		3-0 3/4	
FRAME		3-0	
GLASS		33 15/16	
1-6 1/2			
1-6	16		
		4-6 3/4	
		4-6	
		51 15/16	
2-3 1/2			
2-3	25		
		6-0 3/4	
		6-0	
		69 15/16	
3-0 1/2			
3-0	34		
		4-0 3/4	
		4-0	
		45 15/16	
2-0 1/2			
2-0	22		





### Double Hung

ROUGH		2-2 1/8	
FRAME		2-1 3/8	
GLASS		23 15/16	
1-1 3/16			
1-0 11/16	10		
		3-2 1/8	
		3-1 3/8	
		35 5/16	
1-7 3/16			
1-6 11/16	16 11/16		
		4-3 1/2	
		4-2 3/4	
		48 11/16	
2-1 7/8			
2-1 3/8	23 3/8		
		5-11 1/2	
		5-10 3/4	
		68 11/16	
2-11 7/8			
2-11 3/8	33 3/8		
		7-11 1/2	
		7-10 3/4	
		92 11/16	
3-11 7/8			
3-11 3/8	45 3/8		





  

ROUGH		2-6 1/8	
FRAME		2-5 3/8	
GLASS		27 5/16	
1-3 3/16			
1-2 11/16	12 11/16		
		3-6 1/8	
		3-5 3/8	
		39 5/16	
1-9 3/16			
1-8 11/16	18 11/16		
		4-11 1/2	
		4-10 3/4	
		56 11/16	
2-5 7/8			
2-5 3/8	27 3/8		
		6-3 1/2	
		6-2 3/4	
		72 11/16	
3-1 7/8			
3-1 3/8	35 3/8		
		4-2 1/8	
		4-1 3/8	
		47 5/16	
2-1 1/4			
2-0 11/16	22 11/16		





  

ROUGH		2-8 1/8	
FRAME		2-7 3/8	
GLASS		29 5/16	
1-4 3/16			
1-3 11/16	13 11/16		
		3-10 3/8	
		3-9 3/8	
		43 5/16	
1-11 3/16			
1-10 11/16	20 11/16		
		5-3 1/2	
		5-2 3/4	
		60 11/16	
2-7 7/8			
2-7 3/8	29 3/8		
		6-5 7/8	
		6-4 1/8	
		74 1/8	
3-2 9/16			
3-2 1/16	36 1/16		
		5-2 1/8	
		5-1 3/8	
		59 5/16	
2-7 1/4			
2-6 11/16	28 11/16		

ROUGH		2-10 1/8	
FRAME		2-9 3/8	
GLASS		31 5/16	
1-5 3/16			
1-4 11/16	14 11/16		
		4-0 3/8	
		3-11 3/8	
		45 5/16	
2-0 3/16			
1-11 1/16	21 11/16		
		5-5 7/8	
		5-4 1/8	
		62 1/8	
2-8 9/16			
2-8 1/16	30 1/16		
		6-11 1/2	
		6-10 3/4	
		80 11/16	
3-5 7/8			
3-5 3/8	39 3/8		
		6-2 1/8	
		6-1 3/8	
		71 5/16	
3-1 1/4			
3-0 11/16	34 11/16		

ROUGH		3-0 1/8	
FRAME		2-11 3/8	
GLASS		33 5/16	
1-6 3/16			
1-5 11/16	15 11/16		
		3-7 1/2	
		3-6 3/4	
		40 11/16	
1-9 7/8			
1-8 3/8	19 3/8		
		5-7 1/2	
		5-6 3/4	
		64 11/16	
2-9 7/8			
2-9 3/8	31 3/8		
		7-7 1/2	
		7-6 3/4	
		88 11/16	
3-9 7/8			
3-9 3/8	43 3/8		
		7-5 7/8	
		7-4 1/8	
		86 1/8	
3-8 9/16			
3-8 1/16	42 1/16		

For clad brickmould applications, add 3/8" to rough opening width and height.

**All sizes and specifications subject to change without notice.**



# Pinnacle

## Direct Set

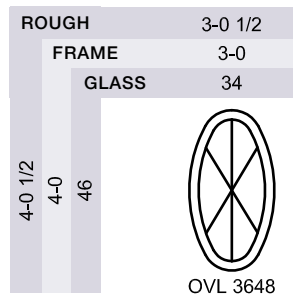
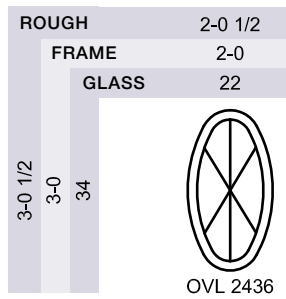
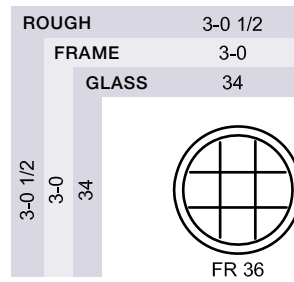
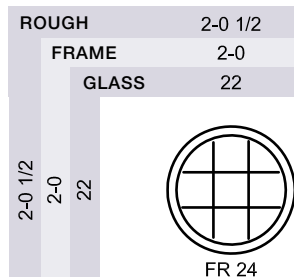

# Pinnacle Clad Direct Set, Direct Set Radius & Corner Technical Drawings

Pinnacle Clad Direct Set

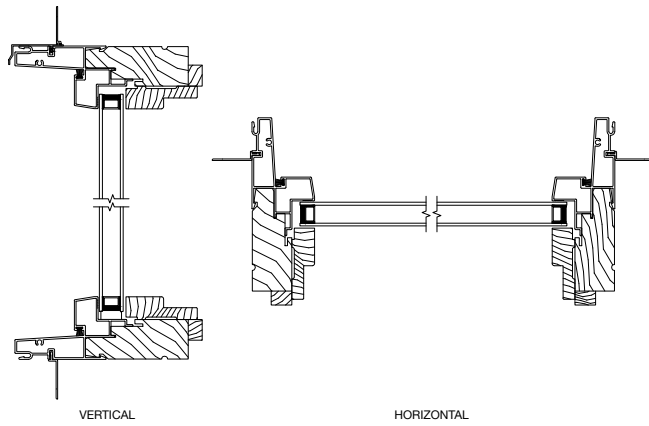

Pinnacle Clad Direct Set Radius

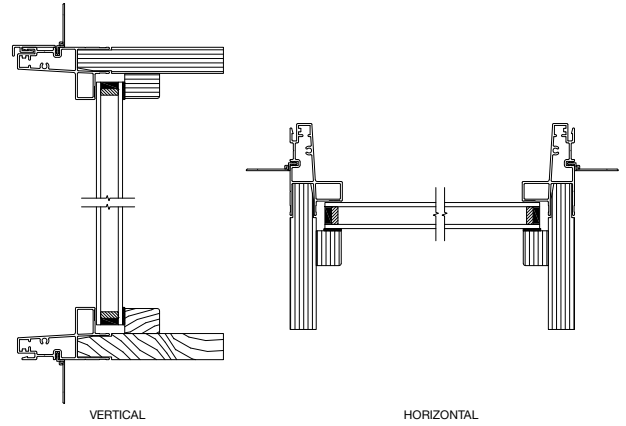

Pinnacle Clad Triple IG Direct Set

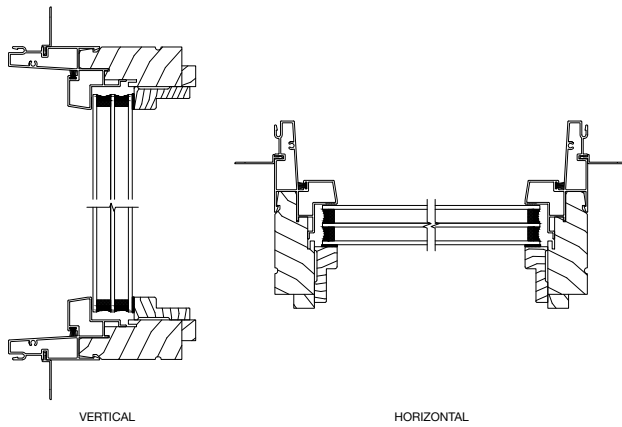

Pinnacle Clad Triple IG Low Profile Direct Set

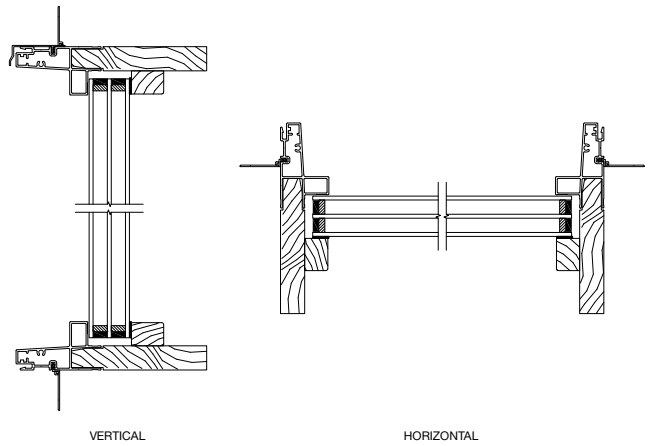

Pinnacle Clad Low Profile Direct Set

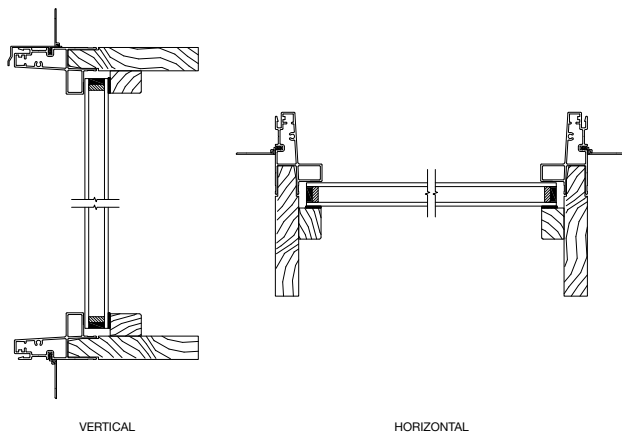

Pinnacle Clad 90-degree Corner

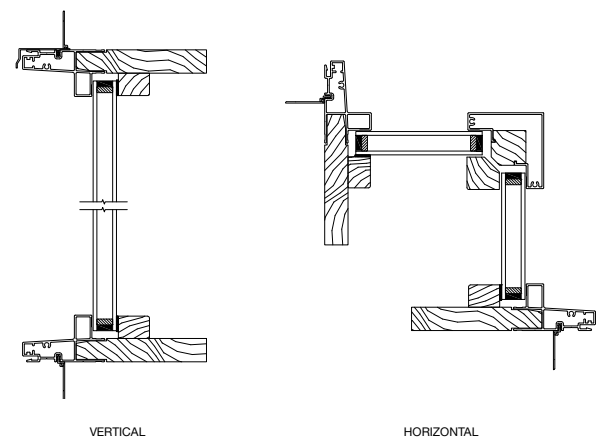

# Pinnacle Primed Direct Set & Direct Set Radius

## Technical Drawings

Pinnacle Primed Direct Set

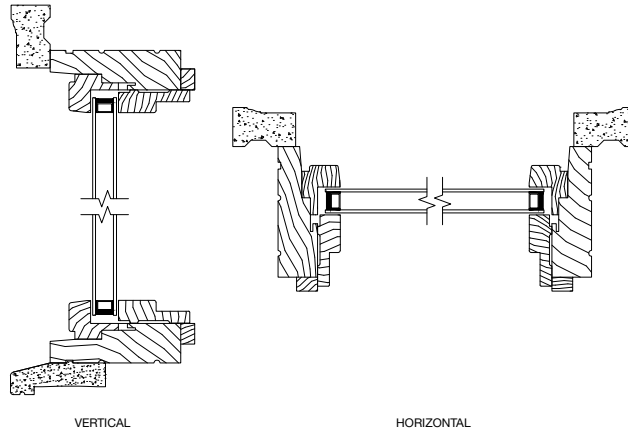

Pinnacle Primed Direct Set Radius

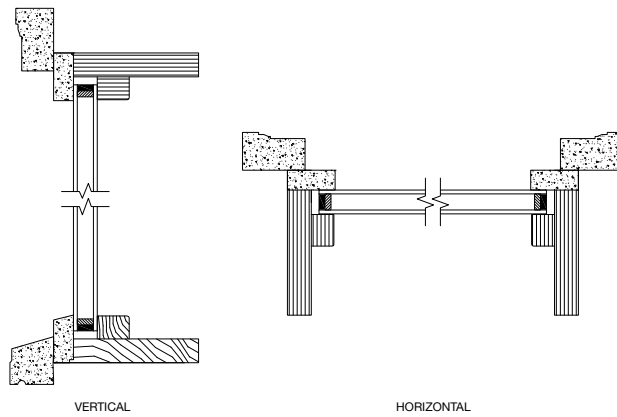









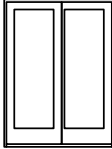
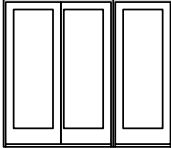
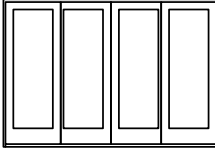

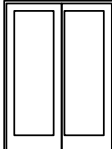
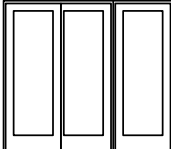
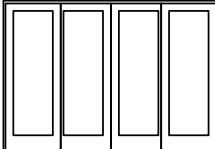

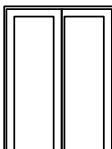
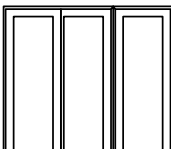
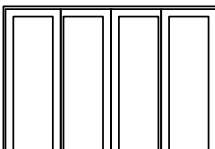

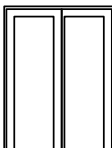

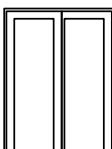









# Pinnacle

## Clad & Primed French Sliding Patio Doors

### Sidelite Sizes

ROUGH	2-8 3/4	4-11 3/4	7-7 3/4	9-9 5/16
FRAME	2-8	4-11	7-7	9-8 9/16
GLASS	21 1/4	21 1/4	21 1/4	21 1/4
6-8 6-7 1/2 64				
2668-S	5068-OX	7668-OX/S	10068-OXXO	
6-11 6-10 1/2 67				
26610-S	50610-OX	76610-OX/S	100610-OXXO	
8-0 7-11 1/2 80				
2680-S	5080-OX	7680-OX/S	10080-OXXO	
9-0 8-11 1/2 92				
2690-S	5090-OX			
10-0 9-11 1/2 104				
26100-S	50100-OX			

ROUGH	1-2 3/4	1-4 3/4	1-6 3/4
FRAME	1-2	1-4	1-6
GLASS	7 1/2	9 1/2	11 1/2
6-8 6-7 1/2 64			
1268	1468	1668	
6-11 6-10 1/2 67			
12610	14610	16610	
8-0 7-11 1/2 80			
1280	1480	1680	
9-0 8-11 1/2 92			
1290	1490	1690	
10-0 9-11 1/2 104			
12100	14100	16100	

----- Clad only





Primed sliders are not available in narrow, only French sliders.  
**All sizes and specifications subject to change without notice.**

# Pinnacle

## Clad & Primed French Sliding Patio Doors

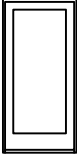
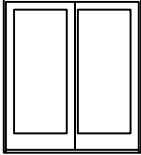
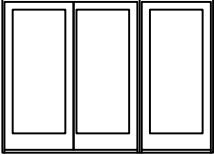
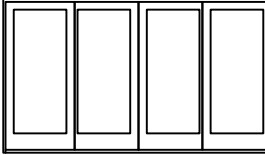
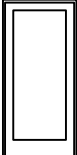
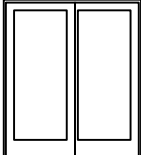
ROUGH	3-2 3/4	5-11 3/4	9-1 3/4	11-9 5/16
FRAME	3-2	5-11	9-1	11-8 9/16
GLASS	27 1/4	27 1/4	27 1/4	27 1/4

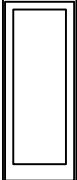
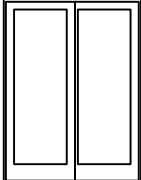

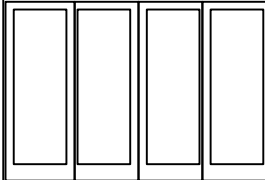
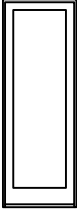
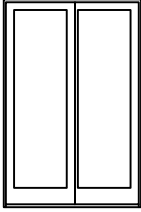
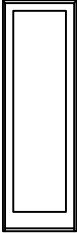
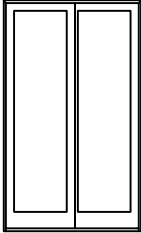
6-8 6-7 1/2 64					
	3068-S	6068-OX	9068-OX/S	12068-OXXO	
	6-11 6-10 1/2 67				
		30610-S	60610-OX	90610-OX/S	120610-OXXO
8-0 7-11 1/2 80					
	3080-S	6080-OX	9080-OX/S	12080-OXXO	
9-0 8-11 1/2 92					
	3090-S	6090-OX			
10-0 9-11 1/2 104					
	30100-S	60100-OX			

----- Clad only

Primed sliders are not available in narrow, only French sliders.  
**All sizes and specifications subject to change without notice.**

## Pinnacle

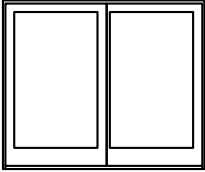
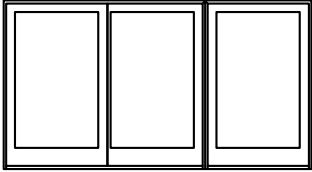
# Clad & Primed French Sliding Patio Doors

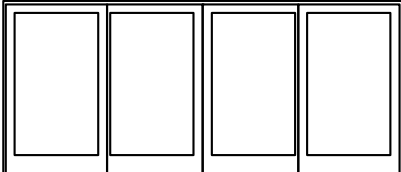
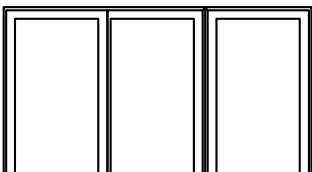





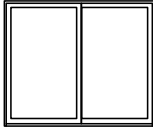
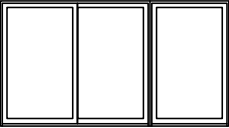
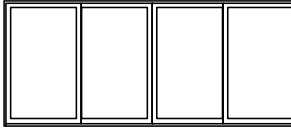

ROUGH	4-2 3/4	7-11 3/4	12-1 3/4	15-9 5/16
FRAME	4-2	7-11	12-1	15-8 9/16
GLASS	39 1/4	39 1/4	39 1/4	39 1/4
6-8 6-7 1/2 64				
	4068-S	8068-OX	12068-OX/S	16068-OXXO
6-11 6-10 1/2 67				
	40610-S	80610-OX	120610-OX/S	160610-OXXO
8-0 7-11 1/2 80				
	4080-S	8080-OX	12080-OX/S	16080-OXXO

Primed sliders are not available in narrow, only French sliders.  
**All sizes and specifications subject to change without notice.**

# Pinnacle

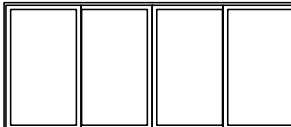
## Clad Narrow Sliding Patio Doors

ROUGH	2-8 3/4	4-11 3/4	7-7 3/4	9-9 5/16
FRAME	2-8	4-11	7-7	9-8 9/16
GLASS	25	25	25	25
6-8 6-7 1/2 71 3/4				
	2668-S	5068-OX	7668-OX/S	10068-OXXO
6-11 6-10 1/2 74 3/4				
	26610-S	50610-OX	76610-OX/S	100610-OXXO
8-0 7-11 1/2 87 3/4				
	2680-S	5080-OX	7680-OX/S	10080-OXXO
9-0 8-11 1/2 99 3/4				
	2690-S	5090-OX		

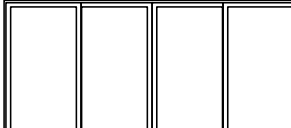
ROUGH	4-2 3/4	7-11 3/4	12-1 3/4	15-9 5/16
FRAME	4-2	7-11	12-1	15-8 9/16
GLASS	43	43	43	43
6-8 6-7 1/2 71 3/4				
	4068-S	8068-OX	12068-OX/S	16068-OXXO
6-11 6-10 1/2 74 3/4				
	40610-S	80610-OX	120610-OX/S	160610-OXXO
8-0 7-11 1/2 87 3/4				
	4080-S	8080-OX	12080-OX/S	16080-OXXO





Not available in primed.

All sizes and specifications subject to change without notice.

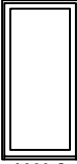
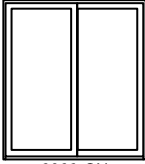
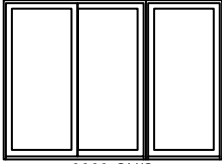
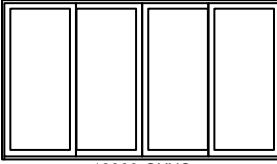
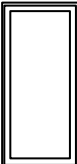
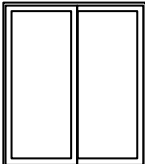
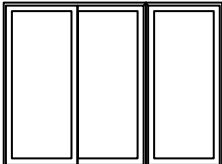

# Pinnacle

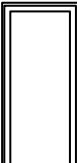
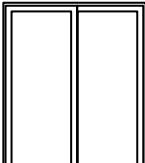
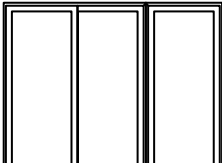
## Clad Narrow Sliding Patio Doors







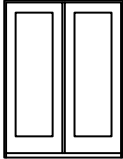
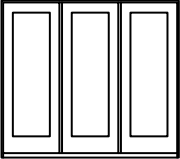
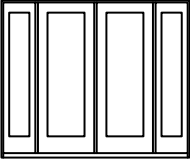
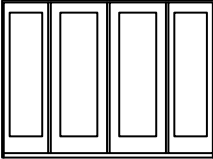
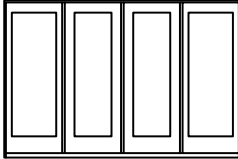

ROUGH	3-2 3/4	5-11 3/4	9-1 3/4	11-9 5/16
FRAME	3-2	5-11	9-1	11-8 9/16
GLASS	31	31	31	31
6-8 6-7 1/2 71 3/4	 3068-S	 6068-OX	 9068-OX/S	 12068-OXXO
6-11 6-10 1/2 74 3/4	 30610-S	 60610-OX	 90610-OX/S	 120610-OXXO
8-0 7-11 1/2 87 3/4	 3080-S	 6080-OX	 9080-OX/S	 12080-OXXO

Not available in primed.

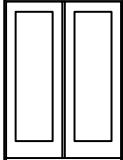
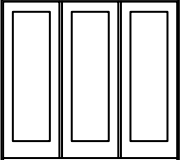
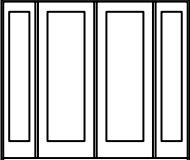
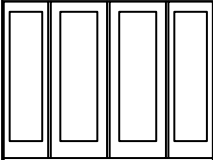
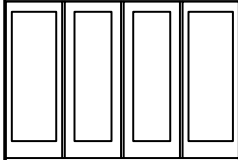
**All sizes and specifications subject to change without notice.**

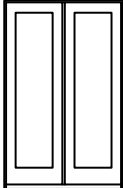
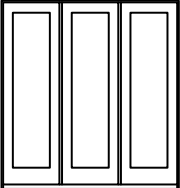
# Pinnacle

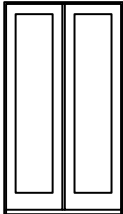
## Clad In-swing Patio Doors

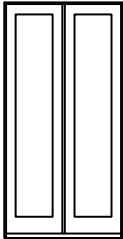
ROUGH	2-7	5-0 13/16	7-6 5/8	7-11 15/16	9-0 7/16	10-0 7/16
FRAME	2-6 1/4	5-0 1/16	7-5 7/8	7-11 3/16	8-11 11/16	9-11 11/16
GLASS	20	20	20	11 1/2 - 20 - 11 1/2	14 - 20 - 14	20
6-8 6-7 1/2 63 7/8						
	2668	5068	7668	16-50-1668	20-50-2068	26-50-2668
6-10 7/8 6-10 3/8 66 3/4						
	26610	50610	76610	16-50-16610	20-50-20610	26-50-26610
7-11 7/8 7-11 3/8 79 3/4						
	2680	5080	7680			
8-11 7/8 8-11 3/8 91 3/4						
	2690	5090				
9-11 7/8 9-11 3/8 103 3/4						
	26100	50100				









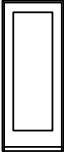
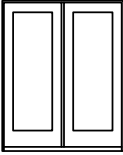
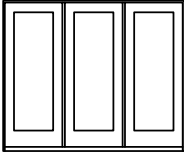
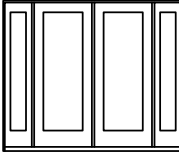
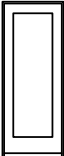
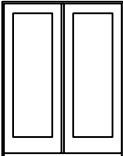
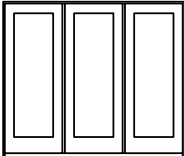
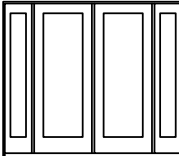
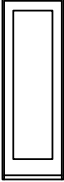
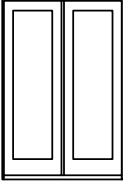
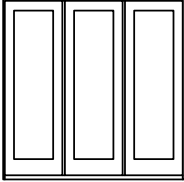
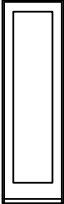
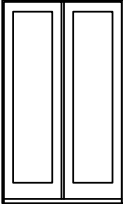
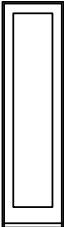
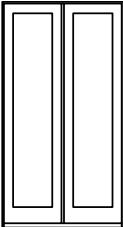



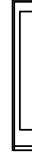



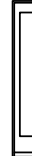

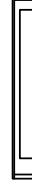

Door handing is determined while standing on the **OUTSIDE** of the door.  
**Left hand door:** Hinges are on the left. **Right hand door:** Hinges are on the right.

**All sizes and specifications subject to change without notice.**

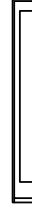
# Pinnacle

## Clad In-swing Patio Doors

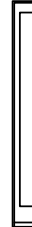
ROUGH	2-9	5-4 13/16	8-0 5/8	7-11 15/16
FRAME	2-8 1/4	5-4 1/16	7-11 7/8	7-11 3/16
GLASS	22	22	22	9 1/2 - 22 - 9 1/2
6-8 6-7 1/2 63 7/8				
2868	5468	8068	14-54-1468	
6-10 7/8 6-10 3/8 66 3/4				
28610	54610	80610	14-54-14610	
7-11 7/8 7-11 3/8 79 3/4				
2880	5480	8080		
8-11 7/8 8-11 3/8 91 3/4				
2890	5490			
9-11 7/8 9-11 3/8 103 3/4				
28100	54100			

ROUGH	1-2 3/4	1-4 3/4	1-6 3/4	2-1
FRAME	1-2	1-4	1-6	2-0 1/4
GLASS	7 1/2	9 1/2	11 1/2	14
6-8 6-7 1/2 63 7/8				
1268	1468	1668	2068	
6-10 7/8 6-10 3/8 66 3/4				
12610	14610	16610	20610	
7-11 7/8 7-11 3/8 79 3/4				
1280	1480	1680	2080	
8-11 7/8 8-11 3/8 91 3/4				
1290	1490	1690	2090	
9-11 7/8 9-11 3/8 103 3/4				
12100	14100	16100	20100	







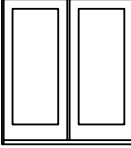
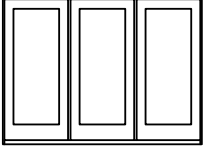
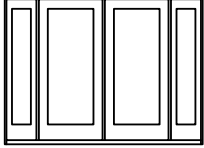
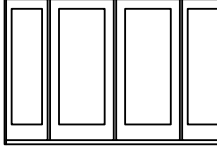

Door handing is determined while standing on the **OUTSIDE** of the door.  
**Left hand door:** Hinges are on the left. **Right hand door:** Hinges are on the right.

**All sizes and specifications subject to change without notice.**

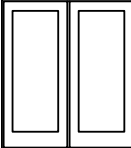
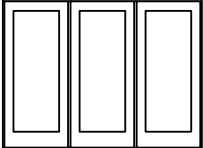
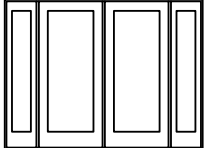
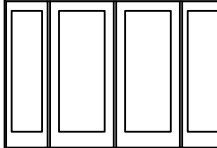
# Pinnacle

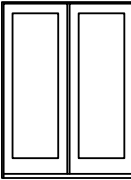
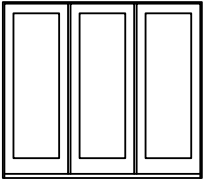
## Clad In-swing Patio Doors

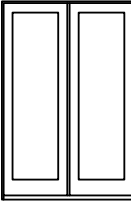
<b>ROUGH</b>	3-1	6-0 13/16	9-0 5/8	8-11 15/16	10-0 7/16
<b>FRAME</b>	3-0 1/4	6-0 1/16	8-11 7/8	8-11 3/16	9-11 11/16
<b>GLASS</b>	26	26	26	11 1/2 - 26 - 11 1/2	14 - 26 - 14

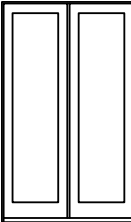
6-8 6-7 1/2 63 7/8						
	3068	6068	9068	16-60-1668	20-60-2068	
	6-10 7/8 6-10 3/8 66 3/4					
		30610	60610	90610	16-60-16610	20-60-20610
	7-11 7/8 7-11 3/8 79 3/4					
3080	6080	9080				
8-11 7/8 8-11 3/8 91 3/4						
3090	6090					
9-11 7/8 9-11 3/8 103 3/4						
30100	60100					

<b>ROUGH</b>	11-0 7/16	12-0 7/16
<b>FRAME</b>	10-11 11/16	11-11 11/16
<b>GLASS</b>	20 - 26 - 20	26

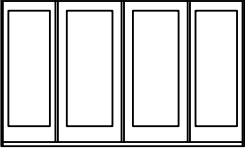
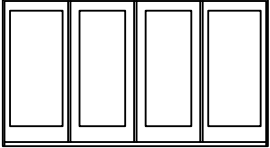
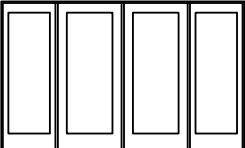
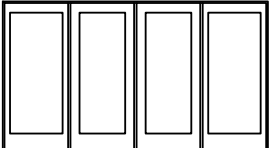
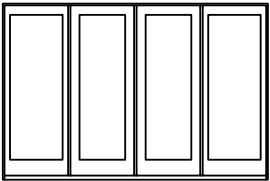
6-8 6-7 1/2 63 7/8		
	26-60-2668	30-60-3068
6-10 7/8 6-10 3/8 66 3/4		
	26-60-26610	30-60-30610
7-11 7/8 7-11 3/8 79 3/4		
	30-60-3080	

Door handing is determined while standing on the **OUTSIDE** of the door.  
**Left hand door:** Hinges are on the left. **Right hand door:** Hinges are on the right.

**All sizes and specifications subject to change without notice.**



# Pinnacle

## Clad In-swing Patio Doors

	ROUGH	3-2 1/2	6-3 13/16
	FRAME	3-1 3/4	6-3 1/16
	GLASS	27 1/2	27 1/2
6-8			
6-7 1/2			
63 7/8			
6-10 7/8			
6-10 3/8			
66 3/4			
7-11 7/8			
7-11 3/8			
79 3/4			
8-11 7/8			
8-11 3/8			
91 3/4			
9-11 7/8			
9-11 3/8			
103 3/4			

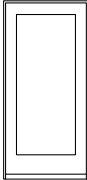

3268

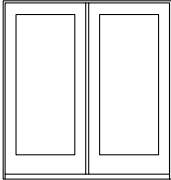

6468

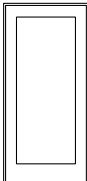

32610

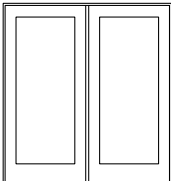

64610

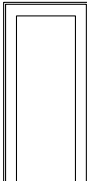

3280

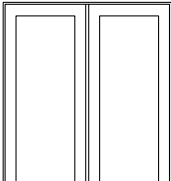

6480

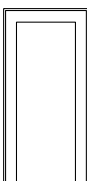

3290

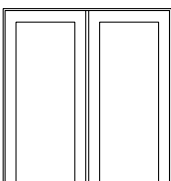

6490

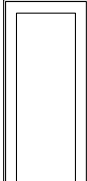

32100

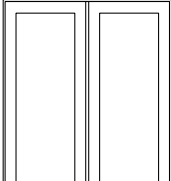

64100

	ROUGH	4-0 3/4
	FRAME	4-0
	GLASS	14
6-8		
6-7 1/2		
63 7/8		
6-10 7/8		
6-10 3/8		
66 3/4		
7-11 7/8		
7-11 3/8		
79 3/4		
8-11 7/8		
8-11 3/8		
91 3/4		
9-11 7/8		
9-11 3/8		
103 3/4		

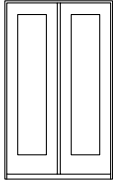

4068  
BI-HINGE ONLY

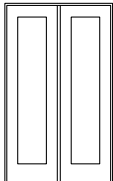

40610  
BI-HINGE ONLY

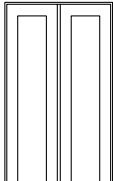

4080  
BI-HINGE ONLY

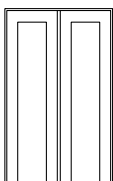

4090  
BI-HINGE ONLY

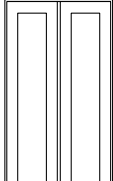

40100  
BI-HINGE ONLY





Door handing is determined while standing on the **OUTSIDE** of the door.  
**Left hand door:** Hinges are on the left. **Right hand door:** Hinges are on the right.





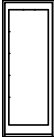
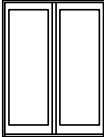
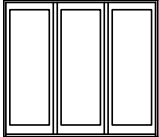
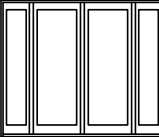
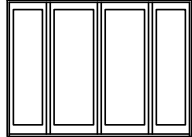
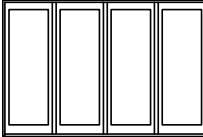

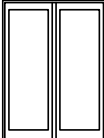
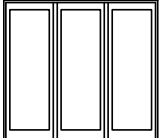
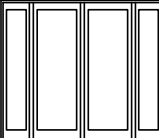
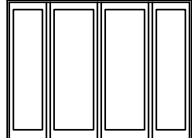
**All sizes and specifications subject to change without notice.**

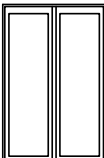
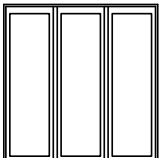

# Pinnacle

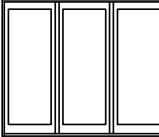
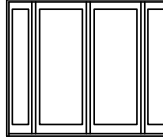
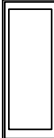
## Clad Narrow In-swing Patio Doors

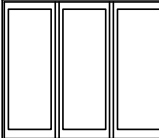
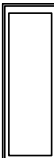
ROUGH	2-7	5-0 13/16	7-6 5/8	7-11 15/16	9-0 7/16	10-0 7/16
FRAME	2-6 1/4	5-0 1/16	7-5 7/8	7-11 3/16	8-11 11/16	9-11 11/16
GLASS	23	23	23	11 1/2 - 23 - 11 1/2	14 - 23 - 14	23
6-8 6-7 1/2 67 1/4						
	2668	5068	7668	16-50-1668	20-50-2068	26-50-2668
	6-10 7/8 6-10 3/8 70 1/8					
26610		50610	76610	16-50-16610	20-50-20610	26-50-26610
7-11 7/8 7-11 3/8 83 1/8						
	2680	5080	7680			

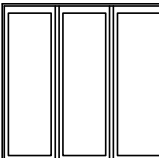
ROUGH	2-9	5-4 13/16	8-0 5/8	7-11 15/16
FRAME	2-8 1/4	5-4 1/16	7-11 7/8	7-11 3/16
GLASS	25	25	25	9 1/2 - 25 - 9 1/2
6-8 6-7 1/2 67 1/4				
	2868	5468	8068	14-54-1468
	6-10 7/8 6-10 3/8 70 1/8			
28610		54610	80610	14-54-14610
7-11 7/8 7-11 3/8 83 1/8				
	2880	5480	8080	

Door handing is determined while standing on the **OUTSIDE** of the door. **Left hand door:** Hinges are on the left. **Right hand door:** Hinges are on the right. The active panel (X) can be placed in any position and hinged in either direction, left (XL) or right (XR). The remaining panel(s) must be in a fixed position.

For doors with handicap sill, subtract 1-3/8" from frame and rough opening heights.

**All sizes and specifications subject to change without notice.**

## Pinnacle

# Clad Narrow In-swing Patio Doors

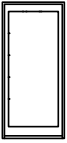
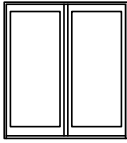
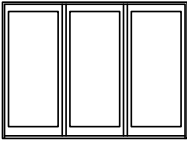
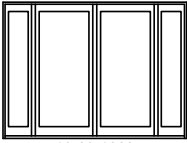
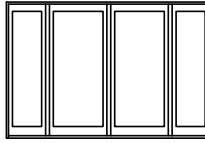
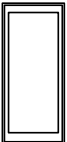
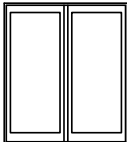
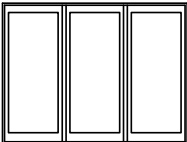
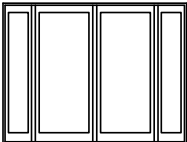
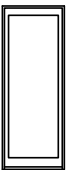
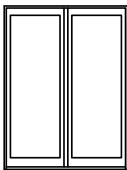
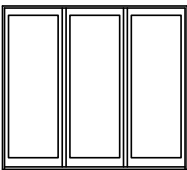
ROUGH	3-1	6-0 13/16	9-0 5/8	8-11 15/16	10-0 7/16
FRAME	3-0 1/4	6-0 1/16	8-11 7/8	8-11 3/16	9-11 11/16
GLASS	29	29	29	11 1/2 - 29 - 11 1/2	17 - 29 - 17
6-8 6-7 1/2 67 1/4					
	3068	6068	9068	16-60-1668	20-60-2068
	6-10 7/8 6-10 3/8 70 1/8				
30610		60610	90610	16-60-16610	20-60-20610
7-11 7/8 7-11 3/8 83 1/8					
	3080	6080	9080		

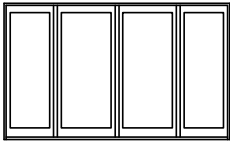
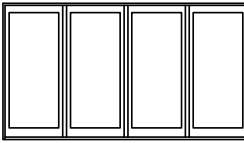
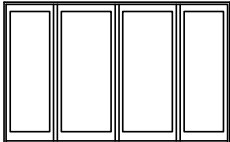
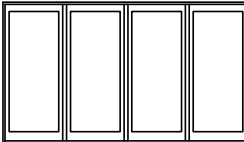
ROUGH	11-0 7/16	12-0 7/16
FRAME	10-11 11/16	11-11 11/16
GLASS	23 - 29 - 23	29
6-8 6-7 1/2 67 1/4		
	26-60-2668	30-60-3068
6-10 7/8 6-10 3/8 70 1/8		
	26-60-26610	30-60-30610

Door handing is determined while standing on the **OUTSIDE** of the door. **Left hand door:** Hinges are on the left. **Right hand door:** Hinges are on the right. The active panel (X) can be placed in any position and hinged in either direction, left (XL) or right (XR). The remaining panel(s) must be in a fixed position.

For doors with handicap sill, subtract 1-3/8" from frame and rough opening heights.

**All sizes and specifications subject to change without notice.**

# Pinnacle

## Clad Narrow In-swing Patio Doors

	ROUGH	3-2 1/2	6-3 13/16	4-0 3/4
	FRAME	3-1 3/4	6-3 1/16	4-0
	GLASS	30 1/2	30 1/2	17

HEIGHT	ROUGH	FRAME	GLASS	MODEL	NOTES
6-8	6-8	3-1 3/4	30 1/2	3268	
6-7 1/2	6-7 1/2	3-1 3/4	30 1/2	6468	
6-7 1/4	6-7 1/4	3-1 3/4	30 1/2	4068	BI-HINGE ONLY
6-10 7/8	6-10 7/8	3-1 3/4	30 1/2	32610	
6-10 3/8	6-10 3/8	3-1 3/4	30 1/2	64610	
7-0 1/8	7-0 1/8	3-1 3/4	30 1/2	40610	BI-HINGE ONLY
7-11 7/8	7-11 7/8	3-1 3/4	30 1/2	3280	
7-11 3/8	7-11 3/8	3-1 3/4	30 1/2	6480	
8-3 1/8	8-3 1/8	3-1 3/4	30 1/2	4080	BI-HINGE ONLY

	ROUGH	1-3	1-5	1-7	2-1 1/4
	FRAME	1-2	1-4	1-6	2-0 1/4
	GLASS	7 1/2	9 1/2	11 1/2	17

HEIGHT	ROUGH	FRAME	GLASS	MODEL
6-8	6-8	1-2	7 1/2	1268
6-7 1/2	6-7 1/2	1-2	7 1/2	1468
6-7 1/4	6-7 1/4	1-2	7 1/2	1668
		1-2	7 1/2	2068
6-11	6-11	1-2	7 1/2	12610
6-10 1/2	6-10 1/2	1-2	7 1/2	14610
7-0 1/8	7-0 1/8	1-2	7 1/2	16610
		1-2	7 1/2	20610
8-0	8-0	1-2	7 1/2	1280
7-11 3/8	7-11 3/8	1-2	7 1/2	1480
8-3 1/8	8-3 1/8	1-2	7 1/2	1680
		1-2	7 1/2	2080





Door handing is determined while standing on the **OUTSIDE** of the door. **Left hand door:** Hinges are on the left. **Right hand door:** Hinges are on the right. The active panel (X) can be placed in any position and hinged in either direction, left (XL) or right (XR). The remaining panel(s) must be in a fixed position.

For doors with handicap sill, subtract 1-3/8" from frame and rough opening heights.

**All sizes and specifications subject to change without notice.**

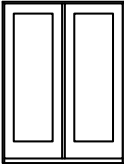
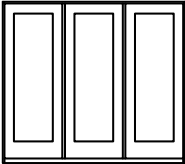
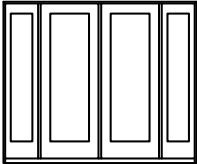
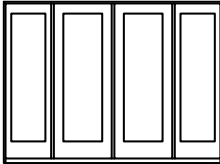
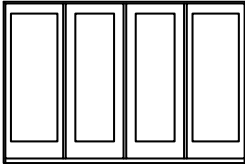
# Pinnacle

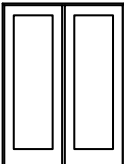
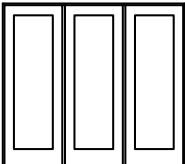
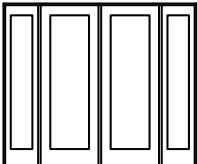
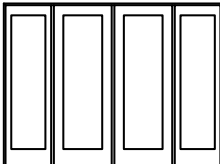
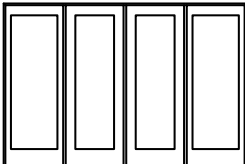
## Primed In-swing Patio Doors

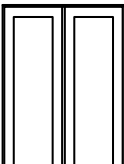
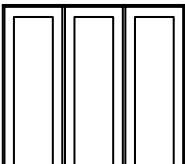
ROUGH	2-6 15/16	5-0 3/4	7-6 9/16	7-11 7/8	9-0 3/8	10-0 3/8		
FRAME	2-6 3/16	5-0	7-5 13/16	7-11 1/8	8-11 5-8	9-11 5-8		
GLASS	20	20	20	11 1/2 - 20 - 11 1/2	14 - 20 - 14	20		
6-8 6-7 1/2 63 7/8								
	2668	5068	7668	16-50-1668	20-50-2068	26-50-2668		
	6-10 7/8 6-10 3/8 66 3/4							
		26610	50610	76610	16-50-16610	20-50-20610	26-50-26610	
		7-11 7/8 7-11 3/8 79 3/4						
			2680	5080	7680			









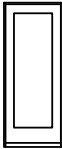
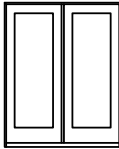
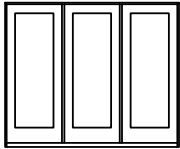
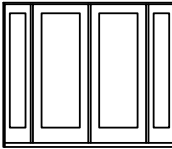
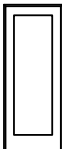
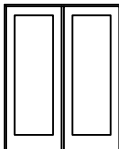
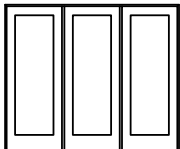
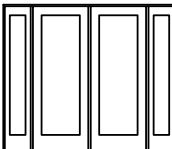
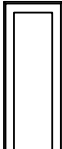
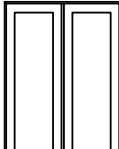
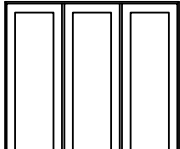



Door handing is determined while standing on the **OUTSIDE** of the door.  
**Left hand door:** Hinges are on the left. **Right hand door:** Hinges are on the right.

**All sizes and specifications subject to change without notice.**

# Pinnacle

## Primed In-swing Patio Doors

ROUGH	2-8 15/16	5-4 3/4	8-0 9/16	7-11 7/8
FRAME	2-8 3/16	5-4	7-11 13/16	7-11 1/8
GLASS	22	22	22	9 1/2 - 22 - 9 1/2
6-8				
	2868	5468	8068	14-54-1468
6-10 7/8				
	28610	54610	80610	14-54-14610
7-11 7/8				
	2880	5480	8080	

ROUGH	1-2 11/16	1-4 11/16	1-6 11/16	2-0 15/16
FRAME	1-1 15/16	1-3 15/16	1-5 15/16	2-0 3/16
GLASS	7 1/2	9 1/2	11 1/2	14
6-8				
	1268	1468	1668	2068
6-10 7/8				
	12610	14610	16610	20610
7-11 7/8				
	1280	1480	1680	2080

Door handing is determined while standing on the **OUTSIDE** of the door.  
**Left hand door:** Hinges are on the left. **Right hand door:** Hinges are on the right.  
**All sizes and specifications subject to change without notice.**









# Pinnacle

## Primed In-swing Patio Doors

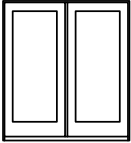
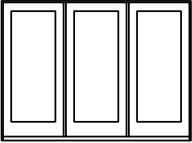
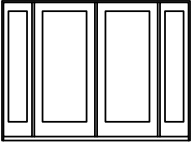
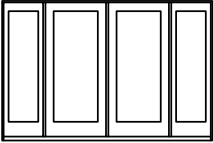
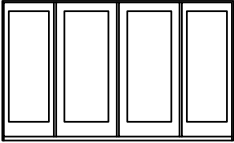
ROUGH	3-0 15/16	6-0 3/4	9-0 9/16	8-11 7/8	10-0 3/8	11-0 3/8
FRAME	3-0 3/16	6-0	8-11 13/16	8-11 1/8	9-11 5-8	10-11 5-8
GLASS	26	26	26	11 1/2 - 26 - 11 1/2	14 - 26 - 14	20 - 26 - 20

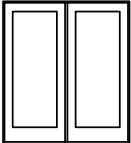
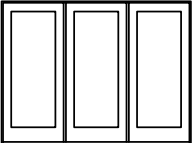
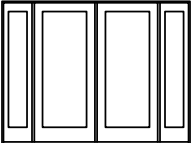
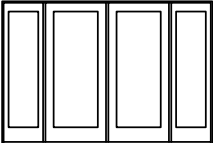
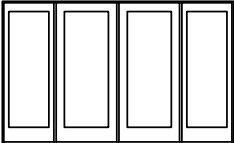
6-8 3/4						
	3068	6068	9068	16-60-1668	20-60-2068	26-60-2668
6-11 5/8						
	30610	60610	90610	16-60-16610	20-60-20610	26-60-26610
8-0 5/8						
	3080	6080	9080			

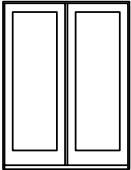
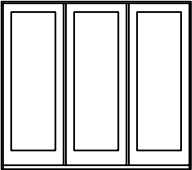
ROUGH	12-2 1/8
FRAME	11-11 5-8
GLASS	12-0 3/8

6-8 3/4	
	30-60-3068

ROUGH	12-2 1/8
FRAME	11-11 5-8
GLASS	12-0 3/8

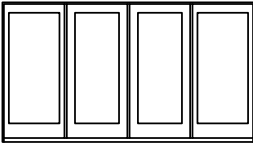
6-11 5/8	
6-10 3/8	
6-10 7/8	
	30-60-30610

ROUGH	12-2 1/8
FRAME	11-11 5-8
GLASS	12-0 3/8

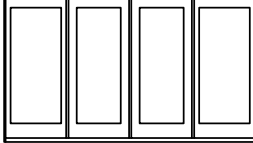
8-0 5/8	
7-11 3/8	
7-11 7/8	
	30-60-3080

Door handing is determined while standing on the **OUTSIDE** of the door.  
**Left hand door:** Hinges are on the left. **Right hand door:** Hinges are on the right.

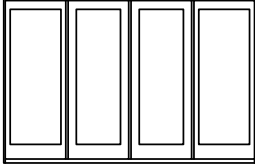
**All sizes and specifications subject to change without notice.**

# Pinnacle

## Primed In-swing Patio Doors

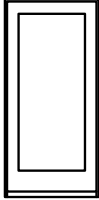
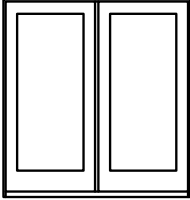
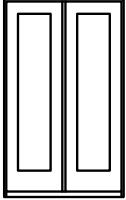
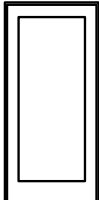
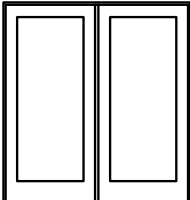
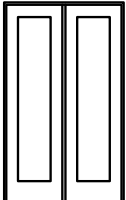
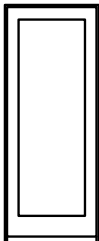
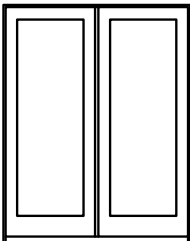
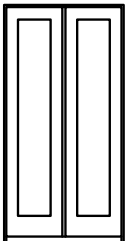
ROUGH	3-2 7/16	6-3 3/4	ROUGH	4-0 3/4
FRAME	3-1 11/16	6-3	FRAME	4-0
GLASS	27 1/2	27 1/2	GLASS	14
6-8			6-8	
6-7 1/2			6-7 1/2	
63 7/8			63 7/8	
	3268	6468		4068 BI-HINGE ONLY
6-10 7/8			6-10 7/8	
6-10 3/8			6-10 3/8	
66 3/4			66 3/4	
	32610	64610		40610 BI-HINGE ONLY
7-11 7/8			7-11 7/8	
7-11 3/8			7-11 3/8	
79 3/4			79 3/4	
	3280	6480		4080 BI-HINGE ONLY

Door handing is determined while standing on the **OUTSIDE** of the door.  
**Left hand door:** Hinges are on the left. **Right hand door:** Hinges are on the right.

**All sizes and specifications subject to change without notice.**



# Pinnacle

## Clad In-swing Radius Segment Top Patio Doors

ROUGH	2-7	5-0 13/16	7-6 5/8
FRAME	2-6 1/4	5-0 1/16	7-5 7/8
GLASS	20	20	20
6-10 7/8	LEG: 6-7 1/32 RADIUS: 3-0	LEG: 6-5 9/16 RADIUS: 8-0	LEG: 6-3 3/16 RADIUS: 12-0
6-10 3/8			
67 1/16	26610	50610	76610
7-11 7/8	LEG: 7-8 1/32 RADIUS: 3-0	LEG: 7-6 9/16 RADIUS: 8-0	LEG: 7-4 3/16 RADIUS: 12-0
7-11 3/8			
80 1/16	2680	5080	7680
8-11 7/8	LEG: 8-8 1/32 RADIUS: 3-0	LEG: 8-6 9/16 RADIUS: 8-0	
8-11 3/8			
92 1/16	2690	5090	

ROUGH	2-9	5-4 13/16	8-0 5/8
FRAME	2-8 1/4	5-4 1/16	7-11 7/8
GLASS	22	22	22
6-10 7/8	LEG: 6-6 1/16 RADIUS: 3-0	LEG: 6-4 3/8 RADIUS: 8-0	LEG: 6-1 21/32 RADIUS: 12-0
6-10 3/8			
67 1/16	28610	54610	80610
7-11 7/8	LEG: 7-7 1/16 RADIUS: 3-0	LEG: 7-5 3/8 RADIUS: 8-0	LEG: 7-2 21/32 RADIUS: 12-0
7-11 3/8			
80 1/16	2880	5480	8080
8-11 7/8	LEG: 8-7 1/16 RADIUS: 3-0	LEG: 8-5 3/8 RADIUS: 8-0	
8-11 3/8			
92 1/16	2890	5490	

Door handing is determined while standing on the **OUTSIDE** of the door.  
**Left hand door:** Hinges are on the left. **Right hand door:** Hinges are on the right.

**All sizes and specifications subject to change without notice.**



# Pinnacle

## Clad In-swing Radius Segment Top Patio Doors

ROUGH	3-1	6-0 13/16	9-0 5/8
FRAME	3-0 1/4	6-0 1/16	8-11 7/8
GLASS	26	26	26

6-10 7/8 6-10 3/8 67 1/16	LEG: 6-4 31/32 RADIUS: 3-0	LEG: 6-2 27/32 RADIUS: 8-0	LEG: 5-11 13/32 RADIUS: 12-0
			
	30610	60610	90610
7-11 7/8 7-11 3/8 80 1/16	LEG: 7-5 31/32 RADIUS: 3-0	LEG: 7-3 27/32 RADIUS: 8-0	LEG: 7-0 13/32 RADIUS: 12-0
			
	3080	6080	9080
8-11 7/8 8-11 3/8 92 1/16	LEG: 8-5 31/32 RADIUS: 3-0	LEG: 8-3 27/32 RADIUS: 8-0	
			
	3090	6090	

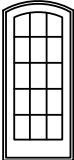
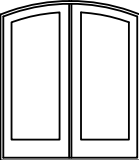
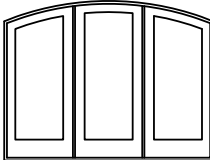
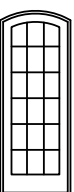
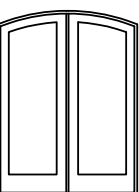
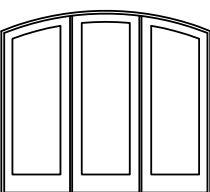
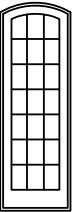
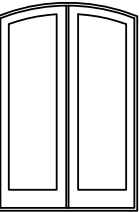
ROUGH	3-2 1/2	6-3 13/16
FRAME	3-1 3/4	6-3 1/16
GLASS	27 1/2	27 1/2

6-10 7/8 6-10 3/8 67 1/16	LEG: 6-4 17/32 RADIUS: 3-0	LEG: 6-2 7/32 RADIUS: 8-0
		
	32610	64610
7-11 7/8 7-11 3/8 80 1/16	LEG: 7-5 17/32 RADIUS: 3-0	LEG: 7-3 7/32 RADIUS: 8-0
		
	3280	6480
6-10 7/8 6-10 3/8 67 1/16	4-0 13/16 4-0 1/16 14 LEG: 6-7 5/16 RADIUS: 8-0	
		
	40610 BI-HINGE ONLY	



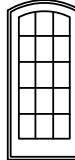
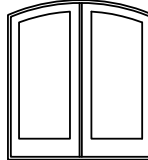
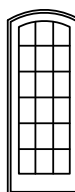
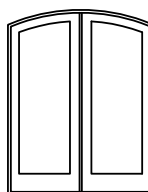
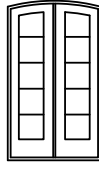



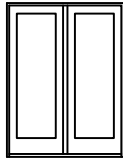
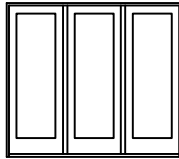
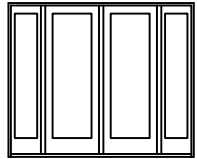
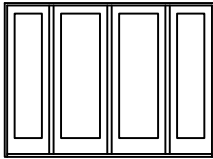
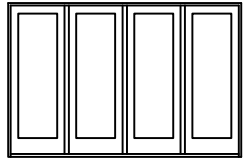

Door handing is determined while standing on the **OUTSIDE** of the door.  
**Left hand door:** Hinges are on the left. **Right hand door:** Hinges are on the right.

**All sizes and specifications subject to change without notice.**

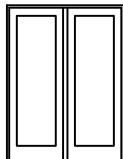
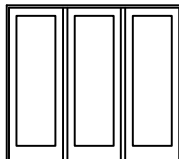
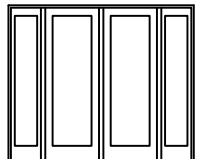
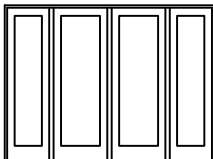
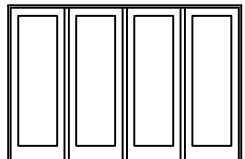

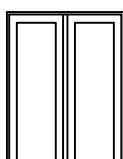
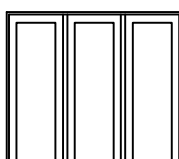
# Pinnacle

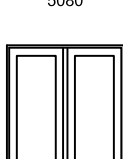
## Clad Out-swing Patio Doors

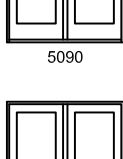
ROUGH	2-7	5-0 13/16	7-6 5/8	8-0 1/16	9-0 9/16	10-0 9/16
FRAME	2-6 1/4	5-0 1/16	7-5 7/8	7-11 5/16	8-11 13/16	9-11 13/16
GLASS	20	20	20	11 1/2 - 20 - 11 1/2	14 - 20 - 14	20
6-7 1/2						
	2668	5068	7668	16-50-1668	20-50-2068	26-50-2668
6-10 3/8						
	26610	50610	76610	16-50-16610	20-50-20610	26-50-26610
7-11 3/8						
	2680	5080	7680			
8-11 3/8						
	2690	5090				
9-11 3/8						
	26100	50100				

Door handing is determined while standing on the **OUTSIDE** of the door.  
**Left hand door:** Hinges are on the left. **Right hand door:** Hinges are on the right.

**All sizes and specifications subject to change without notice.**

# Pinnacle

## Clad Out-swing Patio Doors

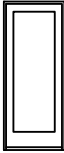
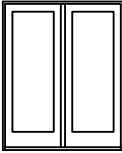
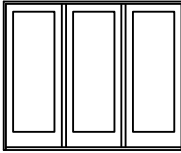
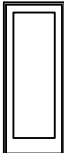
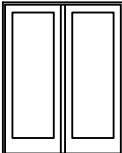
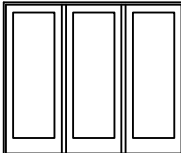
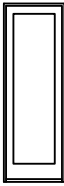
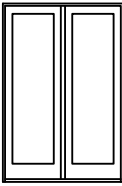
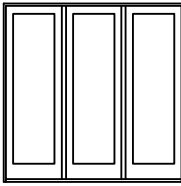
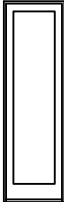
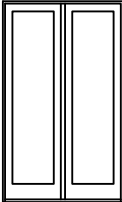
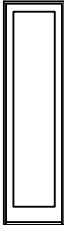
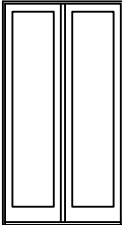
ROUGH	2-9	5-4 13/16	8-0 5/8
FRAME	2-8 1/4	5-4 1/16	7-11 7/8
GLASS	22	22	22
6-7 1/2			
6-7			
63 7/8	2868	5468	8068
6-10 3/8			
6-9 7/8			
66 3/4	28610	54610	80610
7-11 3/8			
7-10 7/8			
79 3/4	2880	5480	8080
8-11 3/8			
8-10 7/8			
91 3/4	2890	5490	
9-11 3/8			
9-10 7/8			
103 3/4	28100	54100	

Door handing is determined while standing on the **OUTSIDE** of the door.  
**Left hand door:** Hinges are on the left. **Right hand door:** Hinges are on the right.









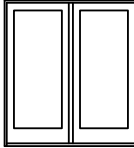
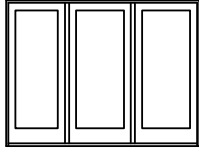
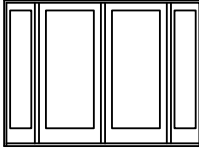
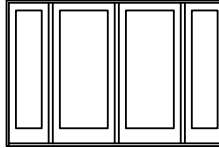

**All sizes and specifications subject to change without notice.**

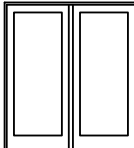
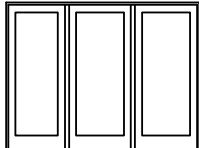
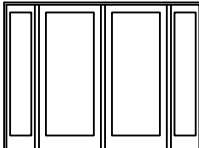
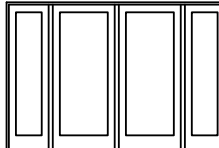

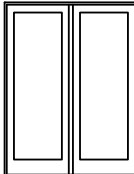
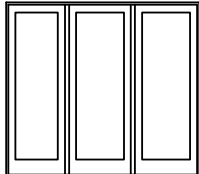
# Pinnacle

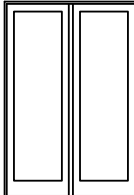
## Clad Out-swing Patio Doors

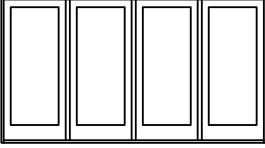
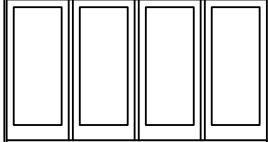
<b>ROUGH</b>	3-1	6-0 13/16	9-0 5/8	9-0 1/16	10-0 9/16
<b>FRAME</b>	3-0 1/4	6-0 1/16	8-11 7/8	8-11 5/16	9-11 13/16
<b>GLASS</b>	26	26	26	11 1/2 - 26 - 11 1/2	14 - 26 - 14

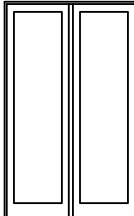
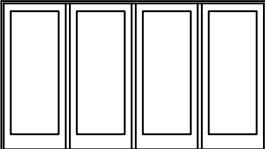
<table border="0"> <tr> <td style="writing-mode: vertical-rl; transform: rotate(180deg);">6-7 1/2</td> <td style="writing-mode: vertical-rl; transform: rotate(180deg);">6-7</td> <td style="writing-mode: vertical-rl; transform: rotate(180deg);">63 7/8</td> </tr> <tr> <td style="writing-mode: vertical-rl; transform: rotate(180deg);">6-10 3/8</td> <td style="writing-mode: vertical-rl; transform: rotate(180deg);">6-9 7/8</td> <td style="writing-mode: vertical-rl; transform: rotate(180deg);">66 3/4</td> </tr> <tr> <td style="writing-mode: vertical-rl; transform: rotate(180deg);">7-11 3/8</td> <td style="writing-mode: vertical-rl; transform: rotate(180deg);">7-10 7/8</td> <td style="writing-mode: vertical-rl; transform: rotate(180deg);">79 3/4</td> </tr> <tr> <td style="writing-mode: vertical-rl; transform: rotate(180deg);">8-11 3/8</td> <td style="writing-mode: vertical-rl; transform: rotate(180deg);">8-10 7/8</td> <td style="writing-mode: vertical-rl; transform: rotate(180deg);">91 3/4</td> </tr> <tr> <td style="writing-mode: vertical-rl; transform: rotate(180deg);">9-11 3/8</td> <td style="writing-mode: vertical-rl; transform: rotate(180deg);">9-10 7/8</td> <td style="writing-mode: vertical-rl; transform: rotate(180deg);">103 3/4</td> </tr> </table>	6-7 1/2	6-7	63 7/8	6-10 3/8	6-9 7/8	66 3/4	7-11 3/8	7-10 7/8	79 3/4	8-11 3/8	8-10 7/8	91 3/4	9-11 3/8	9-10 7/8	103 3/4	 <p>3068</p>	 <p>6068</p>	 <p>9068</p>	 <p>16-60-1668</p>	 <p>20-60-2068</p>
	6-7 1/2	6-7	63 7/8																	
	6-10 3/8	6-9 7/8	66 3/4																	
	7-11 3/8	7-10 7/8	79 3/4																	
	8-11 3/8	8-10 7/8	91 3/4																	
9-11 3/8	9-10 7/8	103 3/4																		
 <p>30610</p>	 <p>60610</p>	 <p>90610</p>	 <p>16-60-16610</p>	 <p>20-60-20610</p>																
 <p>3080</p>	 <p>6080</p>	 <p>9080</p>	<table border="1"> <tr> <td><b>ROUGH</b></td> <td>11-0 9/16</td> <td>12-0 9/16</td> </tr> <tr> <td><b>FRAME</b></td> <td>10-11 13/16</td> <td>11-11 13/16</td> </tr> <tr> <td><b>GLASS</b></td> <td>20 - 26 - 20</td> <td>26</td> </tr> </table>		<b>ROUGH</b>	11-0 9/16	12-0 9/16	<b>FRAME</b>	10-11 13/16	11-11 13/16	<b>GLASS</b>	20 - 26 - 20	26							
<b>ROUGH</b>	11-0 9/16	12-0 9/16																		
<b>FRAME</b>	10-11 13/16	11-11 13/16																		
<b>GLASS</b>	20 - 26 - 20	26																		
 <p>3090</p>	 <p>6090</p>	<table border="0"> <tr> <td style="writing-mode: vertical-rl; transform: rotate(180deg);">6-7 1/2</td> <td style="writing-mode: vertical-rl; transform: rotate(180deg);">6-7</td> <td style="writing-mode: vertical-rl; transform: rotate(180deg);">63 7/8</td> </tr> </table>  <p>26-60-3068</p>  <p>30-30-3068</p>		6-7 1/2	6-7	63 7/8														
6-7 1/2	6-7	63 7/8																		
 <p>30100</p>	 <p>60100</p>	<table border="1"> <tr> <td><b>ROUGH</b></td> <td>11-0 9/16</td> <td>12-0 9/16</td> </tr> <tr> <td><b>FRAME</b></td> <td>10-11 13/16</td> <td>11-11 13/16</td> </tr> <tr> <td><b>GLASS</b></td> <td>20 - 26 - 20</td> <td>26</td> </tr> </table>		<b>ROUGH</b>	11-0 9/16	12-0 9/16	<b>FRAME</b>	10-11 13/16	11-11 13/16	<b>GLASS</b>	20 - 26 - 20	26								
<b>ROUGH</b>	11-0 9/16	12-0 9/16																		
<b>FRAME</b>	10-11 13/16	11-11 13/16																		
<b>GLASS</b>	20 - 26 - 20	26																		
		<table border="0"> <tr> <td style="writing-mode: vertical-rl; transform: rotate(180deg);">6-10 3/8</td> <td style="writing-mode: vertical-rl; transform: rotate(180deg);">6-9 7/8</td> <td style="writing-mode: vertical-rl; transform: rotate(180deg);">66 3/4</td> </tr> </table>  <p>26-60-30610</p>  <p>30-60-30610</p>		6-10 3/8	6-9 7/8	66 3/4														
6-10 3/8	6-9 7/8	66 3/4																		

Door handing is determined while standing on the **OUTSIDE** of the door.  
**Left hand door:** Hinges are on the left. **Right hand door:** Hinges are on the right.

**All sizes and specifications subject to change without notice.**



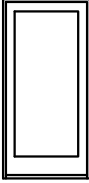
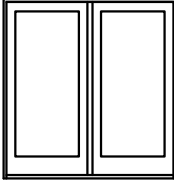
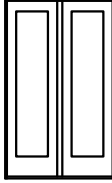
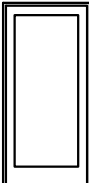
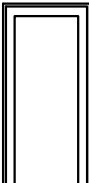
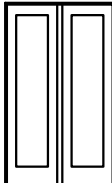
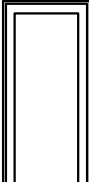
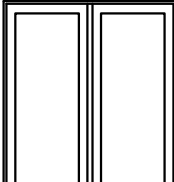
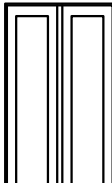
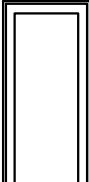

# Pinnacle

## Clad Out-swing Patio Doors

ROUGH		3-2 1/2	6-3 13/16
FRAME		3-1 3/4	6-3 1/16
GLASS		27 1/2	27 1/2
6-7 1/2	6-7		
	63 7/8	3268	6468
6-10 3/8	6-9 7/8		
	66 3/4	32610	64610
7-11 3/8	7-10 7/8		
	79 3/4	3280	6480
8-11 3/8	8-10 7/8		
	91 3/4	3290	6490
9-11 3/8	9-10 7/8		
	103 3/4	32100	64100

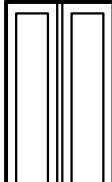
ROUGH		4-0 9/16
FRAME		4-0 1/16
GLASS		14
6-7 1/2	6-7	
	63 7/8	4068 BI-HINGE ONLY
6-10 3/8	6-9 7/8	
	66 3/4	40610 BI-HINGE ONLY
7-11 3/8	7-10 7/8	
	79 3/4	4080 BI-HINGE ONLY
8-11 3/8	8-10 7/8	
	91 3/4	4090 BI-HINGE ONLY
9-11 3/8	9-10 7/8	
	103 3/4	40100 BI-HINGE ONLY

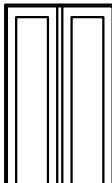
Door handing is determined while standing on the **OUTSIDE** of the door.  
**Left hand door:** Hinges are on the left. **Right hand door:** Hinges are on the right.





**All sizes and specifications subject to change without notice.**

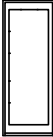
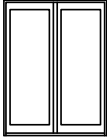
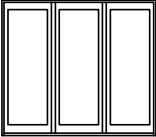
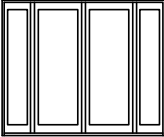
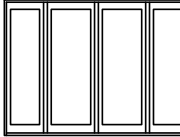
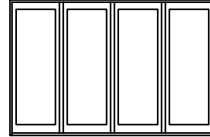
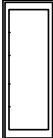
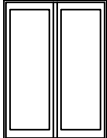
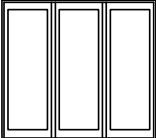
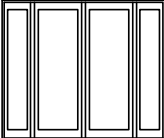
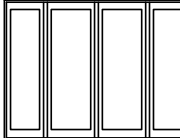
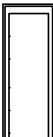
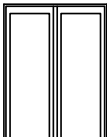
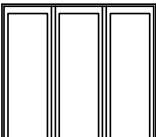

# Pinnacle

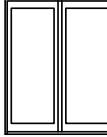
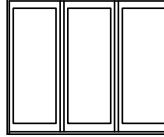
## Clad Narrow Out-swing Patio Doors

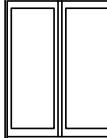
ROUGH	2-7	5-0 13/16	7-6 5/8	8-0 1/16	9-0 9/16	10-0 9/16
FRAME	2-6 1/4	5-0 1/16	7-5 7/8	7-11 5/16	8-11 13/16	9-11 13/16
GLASS	23	23	23	11 1/2 - 23 - 11 1/2	17 - 23 - 17	23
6-7 1/2 6-7 67 1/4						
	2668	5068	7668	16-50-1668	20-50-2068	26-50-2668
	6-10 3/8 6-9 7/8 70 1/8					
26610		50610	76610	16-50-16610	20-50-20610	26-50-26610
7-11 3/8 7-10 7/8 83 1/8						
	2680	5080	7680			

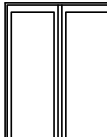
ROUGH	2-9	5-4 13/16	8-0 5/8
FRAME	2-8 1/4	5-4 1/16	7-11 7/8
GLASS	25	25	25
6-7 1/2 6-7 67 1/4			
	2868	5468	8068
	6-10 3/8 6-9 7/8 70 1/8		
28610		54610	80610
7-11 3/8 7-10 7/8 83 1/8			
	2880	5480	8080

Door handing is determined while standing on the **OUTSIDE** of the door. **Left hand door:** Hinges are on the left. **Right hand door:** Hinges are on the right. The active panel (X) can be placed in any position and hinged in either direction, left (XL) or right (XR). The remaining panel(s) must be in a fixed position.

For doors with handicap sill, subtract 1-3/8" from frame and rough opening heights.

**All sizes and specifications subject to change without notice.**

## Pinnacle

# Clad Narrow Out-swing Patio Doors

ROUGH	3-1	6-0 13/16	9-0 5/8	9-0 1/16	10-0 9/16
FRAME	3-0 1/4	6-0 1/16	8-11 7/8	8-11 5/16	9-11 13/16
GLASS	29	29	29	11 1/2 - 29 - 11 1/2	17 - 29 - 17

6-7 1/2 6-7 67 1/4					
	3068	6068	9068	16-60-1668	20-60-2068
	6-10 3/8 6-9 7/8 70 1/8				
30610		60610	90610	16-60-16610	20-60-20610
7-11 3/8 7-10 7/8 83 1/8					
	3080	6080	9080		

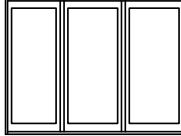
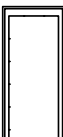
ROUGH	11-0 9/16	12-0 9/16
FRAME	10-11 13/16	11-11 13/16
GLASS	23 - 29 - 23	29

6-7 1/2 6-7 67 1/4		
	26-60-3068	30-30-3068
6-10 3/8 6-9 7/8 70 1/8		
	26-60-30610	30-60-30610

Door handing is determined while standing on the **OUTSIDE** of the door. **Left hand door:** Hinges are on the left. **Right hand door:** Hinges are on the right. The active panel (X) can be placed in any position and hinged in either direction, left (XL) or right (XR). The remaining panel(s) must be in a fixed position.

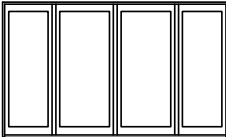
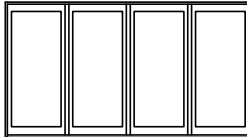
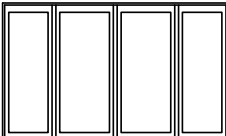
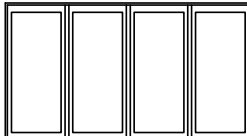







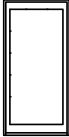
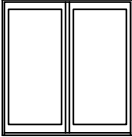
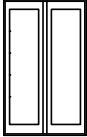
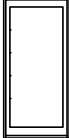
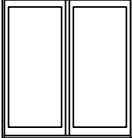
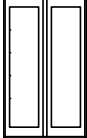
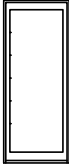
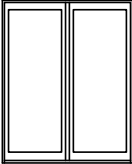
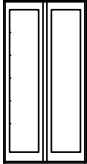

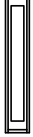
For doors with handicap sill, subtract 1-3/8" from frame and rough opening heights.

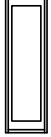
**All sizes and specifications subject to change without notice.**

## Pinnacle

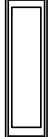
# Clad Narrow Out-swing Patio Doors

	ROUGH	3-2 1/2	6-3 13/16	4-0 9/16	
	FRAME	3-1 3/4	6-3 1/16	4-0 1/16	
	GLASS	30 1/2	30 1/2	17	
6-7 1/2	6-7	67 1/4			
			3268	6468	4068 BI-HINGE ONLY
6-10 3/8	6-9 7/8	70 1/8			
			32610	64610	40610 BI-HINGE ONLY
7-11 3/8	7-10 7/8	83 1/8			
			3280	6480	4080 BI-HINGE ONLY

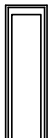
	ROUGH	1-3	1-5	1-7	2-1 1/4	
	FRAME	1-2	1-4	1-6	2-0 1/4	
	GLASS	7 1/2	9 1/2	11 1/2	17	
6-7 1/2	6-7	67 1/4				
			1268	1468	1668	2068
6-10 1/2	6-9 7/8	70 1/8				
			12610	14610	16610	20610
7-11 1/2	7-10 7/8	83 1/8				
			1280	1480	1680	2080

Door handing is determined while standing on the **OUTSIDE** of the door. **Left hand door:** Hinges are on the left. **Right hand door:** Hinges are on the right. The active panel (X) can be placed in any position and hinged in either direction, left (XL) or right (XR). The remaining panel(s) must be in a fixed position.

For doors with handicap sill, subtract 1-3/8" from frame and rough opening heights.

**All sizes and specifications subject to change without notice.**

## Pinnacle

### 1/2 Lite Panel Doors

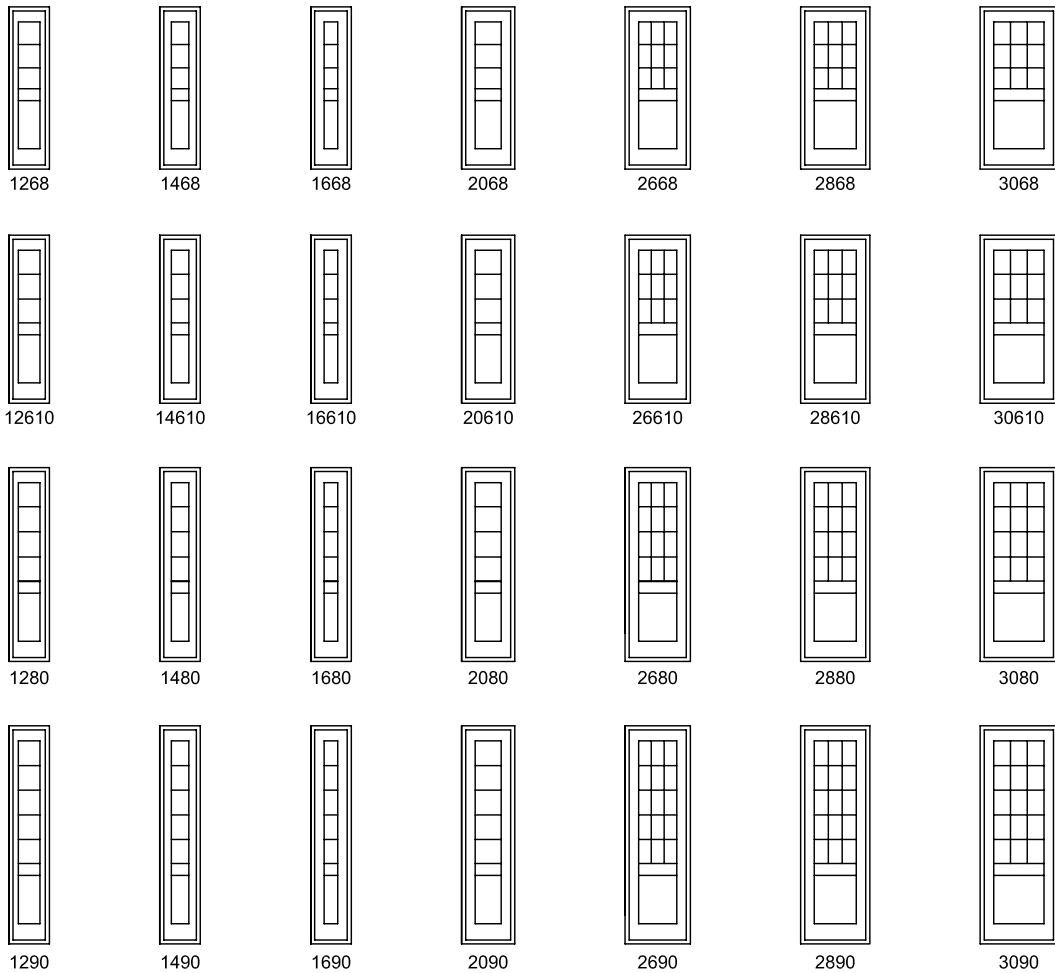

## Pinnacle

### Panel Height & Midrail Locations

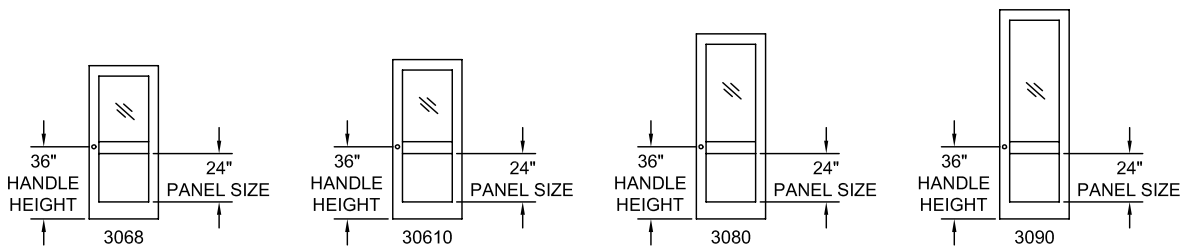

Door handing is determined while standing on the **OUTSIDE** of the door.  
**Left hand door:** Hinges are on the left. **Right hand door:** Hinges are on the right.

**All sizes and specifications subject to change without notice.**



## Pinnacle

### 3/4 Lite Panel Doors

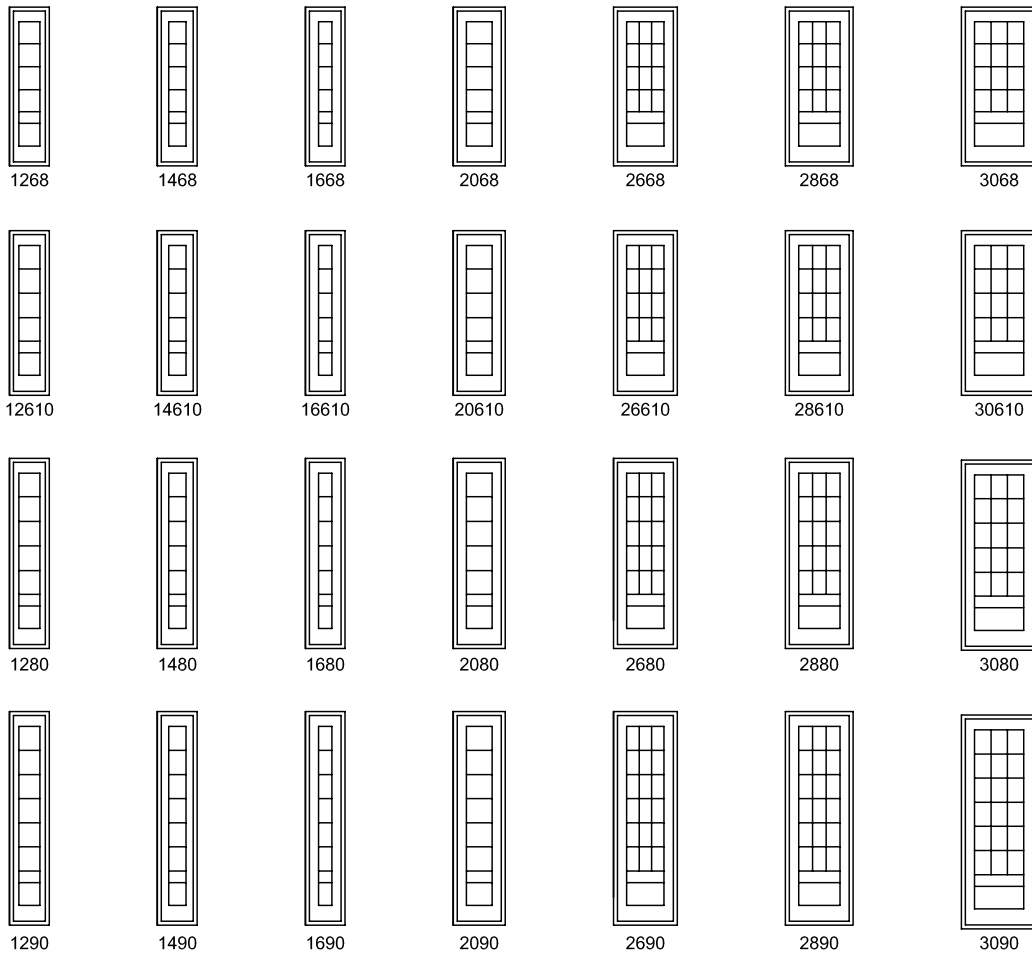

## Pinnacle

### Panel Height & Midrail Locations

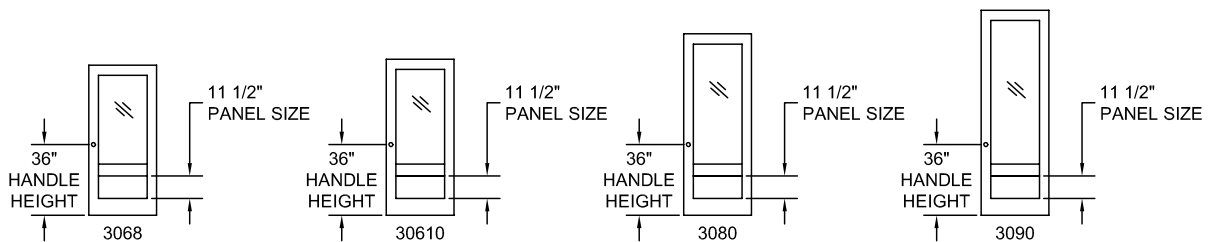

Door handing is determined while standing on the **OUTSIDE** of the door.  
**Left hand door:** Hinges are on the left. **Right hand door:** Hinges are on the right.

**All sizes and specifications subject to change without notice.**

# Pinnacle Sliding Patio Doors

## Technical Drawings

### Pinnacle Clad French Sliding Patio Door

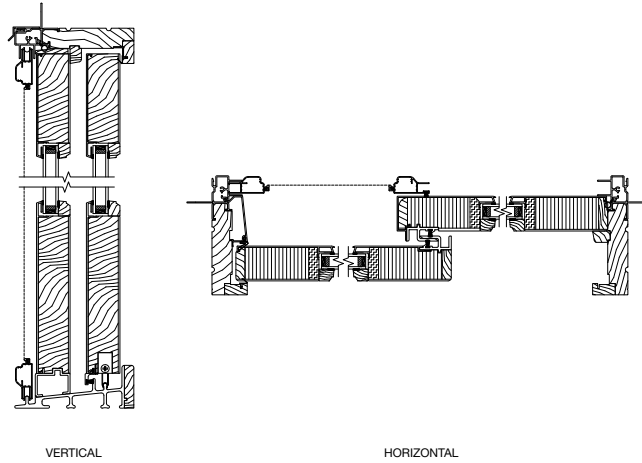

### Pinnacle Clad Narrow Sliding Patio Door

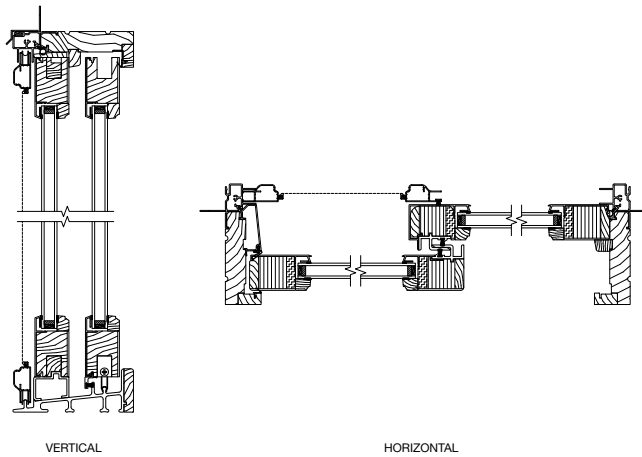

### Pinnacle Primed Sliding Patio Door

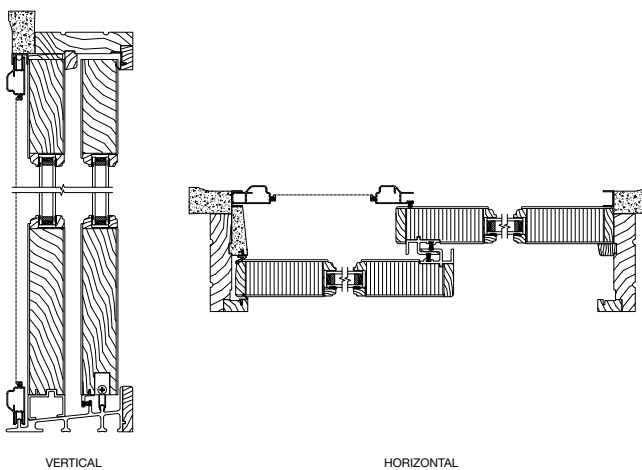

All sizes and specifications subject to change without notice.

# Pinnacle In-swing Patio Doors

## Technical Drawings

Pinnacle Clad In-swing Patio Door

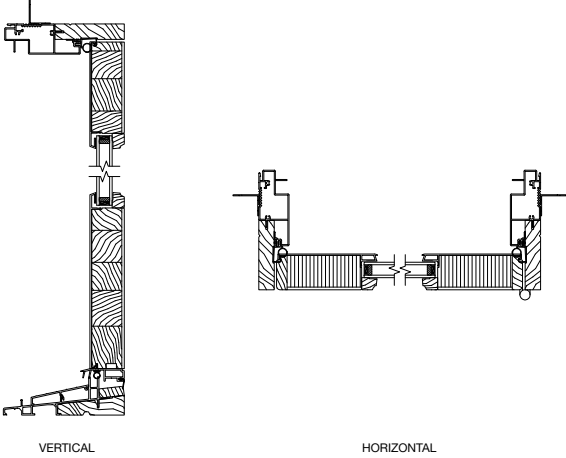

Pinnacle Clad Narrow In-swing Patio Door

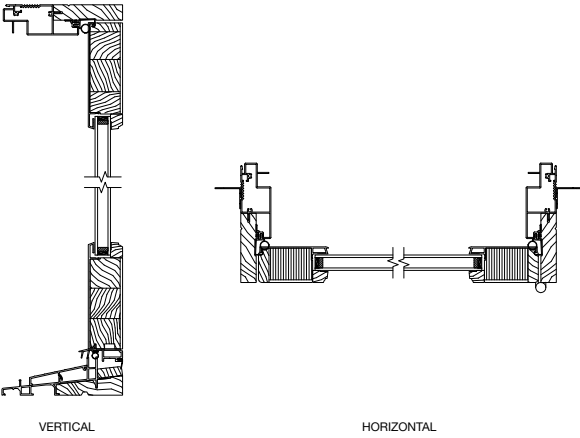

Pinnacle Clad Segment Top In-swing Patio Door

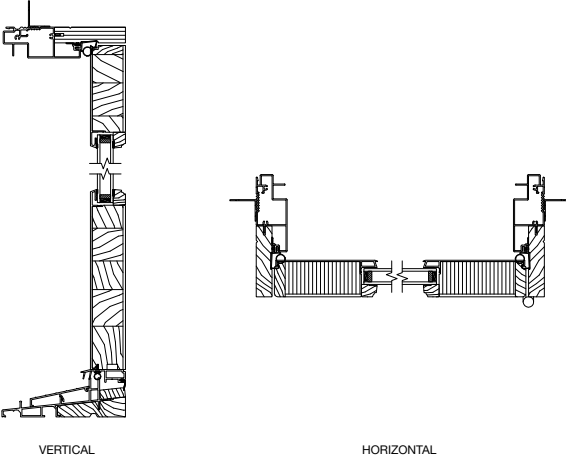

# Pinnacle Out-swing Patio Doors

## Technical Drawings

Pinnacle Clad Out-swing Patio Door

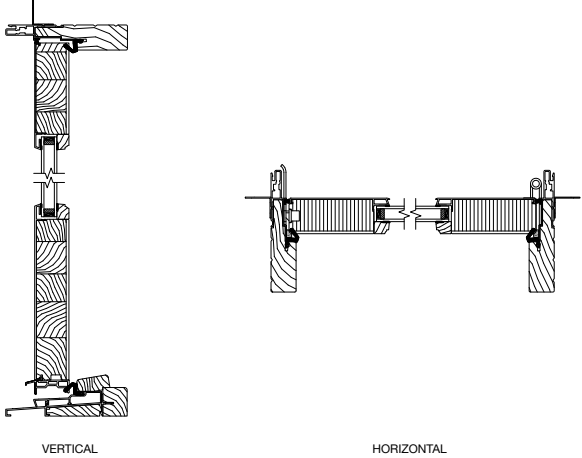

Pinnacle Clad Narrow Out-swing Patio Door

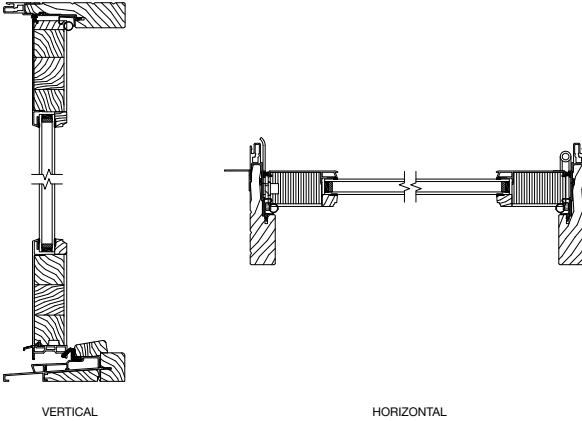

Pinnacle Primed In-swing Patio Door

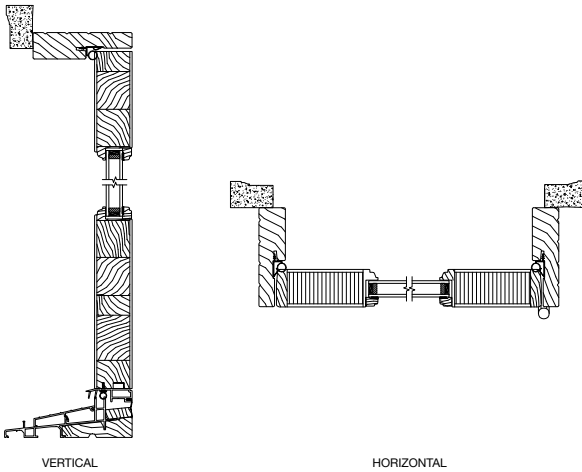

All sizes and specifications subject to change without notice.



# Make every project a success.



**Windsor Windows & Doors has distinct product lines for every application.** New construction. Room additions. Window replacement. Windsor has the solutions to help meet any home building or home improvement need. Discover all of the products we have to offer.

## Pinnacle

The strength and beauty of natural wood define our elite Pinnacle line of products. Crafted from the finest pine, alder and fir, Pinnacle windows and doors add a measure of elegance to any home.

From subtle to showy, Pinnacle products are endlessly customizable through an array of finishes, hardware, shapes, grille options, cladding colors, glass and trim options, allowing the perfect window or door to be created.

Homeowners can choose from the technologically advanced Pinnacle Select, the durable and damage resistant Pinnacle wood clad or Pinnacle primed, which arrives ready to be painted any color.

## Legend

Legend products are constructed from solid cellular PVC, creating the traditional look and feel of painted wood with the low maintenance and strong durability of vinyl. Our windows are protected against rotting, warping, cracking or swelling with a 25-year warranty. Legend products are well suited for both new construction and historical renovation.

Legend HBR products combine the strength and durability of our Legend cellular PVC frame with a wood clad sash. This powerful hybrid offers a low-maintenance exterior with a beautiful wooden interior.

## Next Dimension

Next Dimension Signature windows and doors are robust, reliable products that offer the resilience of extruded multi-chambered vinyl. Enhanced components and sturdy construction add strength and stability. Homeowners enjoy exceptional performance and energy efficiency.

Next Dimension Classic is available in single and double hung units, sliders and sliding patio doors. What makes Next Dimension Classic unique is its sloped sill, tilt sash, brickmould profile frame and decorative features, such as a profiled inner grille and simulated divided lite.

Next Dimension Pro vinyl windows and patio doors are designed for light commercial, multi-family and residential applications, all at a highly competitive price. Vinyl extrusions ensure superior weathering, durability and color retention. Construction features are built in to reduce maintenance, add strength and security, and maximize weather resistance.

All Next Dimension vinyl products are available in white or clay, as well as seven painted exterior colors (white, ivory, tan, bronze, cinnamon, hunter green and black). These products offer commercially rated performance and low maintenance, and are backed by a lifetime limited warranty.

## Revive™ Pocket Replacement Windows

There's a lot to love about a home – its unique character, timeless details and genuine craftsmanship. Drafty, unsightly windows can easily steal away from the beauty of these features. That's where Revive pocket replacement windows come into the picture.

Each window can be transformed with stunning Windsor quality in about an hour – with fewer worries about disturbing any treasured wood trim or other interior and exterior features. And because they're meticulously built to order with customizable features in three high-quality materials (wood clad, hybrid and vinyl), Windsor Revive pocket replacement windows are a fast, uncomplicated upgrade.

## Revive Sash Replacement Kit

Replace old, drafty, inefficient double hung sashes with energy efficient, dual pane sashes. Windsor's Revive Sash Replacement Kit makes updating easy, allowing homeowners to leave existing interior trim and plaster in place. Choose from three different replacement sashes: versatile primed wood, durable aluminum clad or low-maintenance cellular PVC. Revive sashes feature EZ Tilt, which provides fast access for hassle-free cleaning.



900 South 19th Street • West Des Moines, IA 50265 • 515.223.6660 • 800.218.6186  
2210 Stafford Street Extension • Monroe, NC 28110 • 704.283.7459 • 800.205.5665  
[www.windsorwindows.com](http://www.windsorwindows.com)

© 2018 Woodgrain Millwork Inc. Woodgrain Millwork, Windsor, the Windsor Lion logo, Next Dimension and Legend are registered trademarks of Woodgrain Millwork Inc. Windsor Windows & Doors, Pinnacle, Revive and Redstone are trademarks of Woodgrain Millwork Inc.



*Windsor Windows & Doors is an ENERGY STAR® partner and an NFRC, USGBC and WDMA member. Windsor products are certified and labeled according to the guidelines established by the National Fenestration Rating Council (NFRC).*

Connect With Us

